

ADDENDUM NO. 2

Date: February 7, 2025

Project Name: Apiculture Facility

Project No.: 132

SCO ID: 22-24494-01A Code: 42124 Item: 315

NCSU: 202220007

The following clarifications, amendments, additions, deletions, revisions, and modifications are hereby made a part of the Contract Documents and change the original documents only in the manner and to the extent stated below.

BIDDING QUESTIONS AND RESPONSES

1. **Question:** *“What size is the fuel tank for the generator?”*

Response: Refer to revised Specification Section 26 3214 “Engine Generators – Diesel.”

2. **Question:** *“Can a spec section be included for roller shades per finish note 5 on A221?”*

Response: Roller shades are not required. Refer to revised Sheet A221.

3. **Question:** *“3/A404 shows Timber Cladding at the underside of the slope roof, but on the exploded detail 3/A503, metal soffit panel is shown. What is the intension of the ceiling material needed in this area?”*

Response: Refer to revised Sheet A503.

4. **Question:** *“Regarding the spec section 092400-3, Cement Plastering, can the location of this plastering be identified? The only indication on the drawings for plastering occurs on G001 within the legend labeled “Gyp.Bd.,” yet the partition types on A201 only show partitions with gypsum board”*

Response: “Cement Plastering” refers to the stucco soffits on the exterior of the building. The terms should be considered synonymous.

5. **Question:** *“Could pictures of the existing house for Alternate #10 be provided for the interior and exterior and include pictures/detail regarding the partial basement that is to be infilled?”*

Response: A site visit was offered as part of Addendum No. 1. No photos are available.

6. **Question:** *“For openings 102.1 & 102.2...”*

- a. *“Will all panels be required to be stored on 1 side of opening or will they be bi-parting?”*

Response: They will be stored to the true north side of Meeting 102. Bi-parting is not desired.

- b. *“Could you provide finishes of the trop track and door frames?”*

Response: Refer to revised Specification Section 08 3513.13 “Multipanel Folding Aluminum-Framed Glass Doors.”

- c. *“Are the panels folding towards space 101 or 102?”*

Response: The panels shall stack in Meeting 102.

- d. *“What type of floor channel? Standard 1” x 1” recessed floor channel OR ADA compliant threshold?”*

Response: A low-profile saddle sill that is ADA compliant is required. Refer to Detail 4/A254.

- e. *“10” tall glass rails are noted in specification. Also, 10” rails are detailed in on A-704 / detail 6. However, the 10” rails are only illustrated on far left and right panels. Shall all panels require the 10” bottom?”*

Response: 10-inch rails are only required at door bottoms.

7. **Question:** *“With the likelihood of different manufactures being used for roofing material and soffit panels, the chances of matching the soffit color with the roof color would be slim, as indicated in the Soffit Panels specifications. Could you verify that this is what is to be quoted, or if the soffit panels can be quoted with the manufacturer’s standard color?”*

Response: Color matching is required.

8. **Question:** *“Metal Roofing Systems, Inc. is shown as an acceptable manufacturer for standing-seam roof panels (074113), but not soffit panels (074293) or formed metal wall panels (074213). Similarly, Morin is shown as a manufacturer for formed metal wall panels, but no for soffit panels or standing-seam metal roof panels. Would either of these manufacturers be acceptable for the three facade components stated within this RFI, similarly to the manufacturer “PAC-CLAD,” who is shown in all three spec sections?”*

Response: Refer to revised Specification Sections 07 4213.13 “Formed Metal Wall Panels,” and 07 4293 “Soffit Panels.”

9. **Question:** *“On page A112, detail 1 shows an “Incubator CU” with the note underneath stating, “Alternate NO.10.” Similarly, M102 at the Incubator location shows that the incubator and associated CU is to be provided by the GC, while the architectural state that the incubator is provided by the owner. Please confirm that alternate #10 is for the “Existing House and Septic Demolition,” and the incubator is to be provided by the owner and not the GC.”*

Response: The Incubator is owner supplied, and contractor coordinated. Utilities are by Contractor with connections by Owner. Refer to Revised Sheet A112.

10. **Question:** "Please confirm that Duke will handling the Duke primary duck bank and is outside this scope."

Response: The EC is responsible for providing the primary conduit with pull string and coordinating final stub up location with Duke Energy. The EC is also responsible for pouring the transformer pad.

11. **Question:** "Please confirm that if NC State is already handling site up to fine grading that they will also be covering U/G locating that can be referenced for this scope."

Response: Contractor is responsible to prepare site for turnover to owner with planted areas (including lawns) free of construction debris. Planted areas (including lawns) to be graded, decompacted, scarified and prepared for planting soil prior to site turnover to owner". The contractor is responsible for all grading.

12. **Question:** "Please confirm if 3rd party inspections will be covered under the GC including concrete, steel, soil / earthwork, and envelope testing."

Response: Materials testing will be provided by the Owner. Envelope testing shall be provided by the Contractor.

13. **Question:** "Standing seam roof spec lists a 24" width x 1.5" high rib mechanically seamed roof panel which is not an option for the manufacturer's specified. For an 1.5" seam the widest standard panels are 20", which generally are not a tested panel profile. Please confirm if 18" wide x 1.5" high rib from the manufacturer's specified is acceptable?"

Response: Refer to revised Specification Section 07 41 13.16 "Standing Seam Metal Roof Panels."

14. **Question:** "For the soffit panel spec, it is noted .75" panel height, for the PAC Clad (one of the manufacturer's listed in the spec) 1" is common. Please confirm if this is acceptable?"

Response: This is acceptable.

15. **Question:** "The drawings indicate 4" ridge insulation and a coverboard at the roof, but specs don't specify a material. Please confirm material and thickness of the coverboard"

Response: Roof sheathing is specified in 06 1600 "Sheathing."

16. **Question:** "A701 Detail 11 show the flooring in the bathrooms to be a thin set tile floor. If taken to the blow up on Sheet A750 detail 1 it shows a sloped mortar bed. On the same sheet A750 Detail 2 shows what is shown on A701 Please confirm if a mortar bed is required and which detail to follow."

Response: Men's 108 and Women's 109 require thinset, TCNA F115. Storage/Toilet 107C requires thickset, TCNA F121 with tile sloped to drain. Refer to revised Sheet A701.

17. **Question:** *“If earthwork - to fine grading is to be taken care of by the owner - will this also include the swales for the storm drainage? Please confirm the limits of the grading that will already be completed before construction”*

Response: L7.00 Notes state, “All paths, plant bed preparation, landscaping, and site furnishings by owner. Contractor is responsible to prepare site for turnover to owner with planted areas (including lawn areas) free of construction debris. Planted areas to be graded, decompacted, scarified and prepared for planting soil prior to site turnover to owner”. The contractor is responsible for all grading as shown on sheet C5.00 Grading & Storm Drainage Plan.

18. **Question:** *“Just wanting to confirm all landscaping and site furnishings ARE by the Owner?”*

Response: Correct, all plant bed preparation, landscaping, and site furnishings are by owner.

19. **Question:** *“We spoke with our subcontractors/vendors and based on the long lead-times; we feel the Period of Performance of 240 Days is not feasible. Can you please review the POP and let us know if that can be extended?”*

Response: The Contract Duration of 240 days shall remain for bidding purposes. We will work with the successful bidder to identify long-lead items and may adjust the contract duration if proper documentation is provided. Additionally, the Owner may elect to execute a beneficial occupancy process to accept the building while non-critical items are procured (e.g. generator).

20. **Question:** *“Can we wait to issue the NTP until all long lead time items are delivered / expected to be delivered on-site?”*

Response: No.

21. **Question:** *“VWC-1 refers to dreamscape vinyl wall covering. Room #101 and 108 show a need for this but the arrows simply point to the very corners of the wall. Can you clarify what is being requested.”*

Response: The arrows on the finish plans represent the extent of the finish material (i.e. corner-to-corner coverage).

22. **Question:** *“Can you provide us with an engineer plan or a permit from the Environmental Health Department with the County to price septic on scope?”*

Response: Please see sheets C6.00 and C6.90 for septic system scope. Environmental Health Department permit is pending.

23. **Question:** *“Can you please provide us information on the existing/preferred Fire-Alarm system (brand/model) and the contractor / company maintaining the same?”*

Response: The fire alarm system will be new. There is no existing fire alarm system and references to an existing system will be removed from the specifications.

24. **Question:** *“Can you please confirm if Fine Grading, Landscaping, Mulch Paths and Seating is by NCSU?”*

Response: L7.00 Notes state, “All paths, plant bed preparation, landscaping, and site furnishings by owner. Contractor is responsible to prepare site for turnover to owner with planted areas (including lawn areas) free of construction debris. Planted areas to be graded, decompacted, scarified and prepared for planting soil prior to site turnover to owner”. The contractor is responsible for all grading. See sheet C5.00 Grading & Storm Drainage.

25. **Question:** *“Is there a manufacturer drawing for specifications for Foodservice Equipment?”*

Response: No.

26. **Question:** *“Any rolling traffic (carts, pallet jacks, hand trucks etc... to be used inside the box?”*

Response: Lightweight items only. We do not expect any pallet jacks will be used.

27. **Question:** *“Was there any sizing of refrigeration components done, on what appears to be a long run of line sets?”*

Response: Refrigerant piping lengths are within the manufacturers required limits.

28. **Question:** *“Is there an intended route for the refrigeration lines? We do not see anything on mechanical drawings?”*

Response: The refrigerant lines for the walk-in freezer shall run through Equipment Storage 112 and through the mechanical yard. The refrigerant piping running through the mechanical yard shall be vertically stacked and tight to the plan south screen wall.

29. **Question:** *“On sheet L7.00 In the ground cover list it is calling for "decomposed granite" . Is there any chance we could get a spec on this or a specific product?”*

Response: See detail 9/L7.20 for stabilized decomposed granite pathway. An acceptable product is Kafka Granite with Organic-Lok stabilizer or approved equal.

30. **Question:** *“Also plant material etc is shown to be supplied by the owner?”*

Response: Correct.

31. **Question:** *“Is concrete encasement required on the Comm duct bank from Rm 111 to Inwood Rd while the majority of the bank appears to be installed under slab.”*

Response: The telecom ductbank is required to be concrete encased where located outside the building slab.

32. **Question:** *“Please confirm the conduit size, count and ending point for the Primary duct bank from the Duke Energy Transformer. If this is to be provided and installed by Duke, please confirm that.”*

Response: The EC shall provide (2) 4” conduits with pull string and coordinate final stub up location with Duke Energy.

33. **Question:** *“Please confirm MC Cable is acceptable as stated per 26 05 19 3.2(b), if so, please confirm that homeruns to panels are to be in conduit.”*

Response: MC Cable is not allowed and will be removed from the specification.

34. **Question:** *“Please provide a detail for fixture type P1 pole bases.”*

Response: Refer to Revised Sheet E101.

35. **Question:** *“Please provide a fixture schedule to include desired pole height for fixture type P1. This fixture is not listed on the fixture schedule.”*

Response: The fixture type is indicated by Drawing Note #1 on E101. The note will be revised to indicate the pole height.

36. **Question:** *“Sheet E506 shows grounding ladder trays and equipment racks in several locations. Who is responsible for providing and installing this ladder tray and equipment racks?”*

Response: The Owner is responsible for installing the ladder tray, equipment racks, and grounding the equipment to the ground bar. The EC is responsible for installing the telecom ground bar and connecting it to the main building distribution ground bar.

37. **Question:** *“Sheet E506 references a blue light phone. Please confirm the location and requirements of this blue light phone.”*

Response: There is no blue light phone in the scope of work.

38. **Question:** *“Is the extent of the mockup of the façade, shown on A101 keynote 1 at plan northwest of building footprint, supposed to depict cut section 1/A403 only? This would show the metal panel and exterior finish carpentry systems.”*

Response: The intent is to capture the items indicated on Detail 1/A403 but also 2/A403 which would include a small section of storefront and the typical exterior wall construction.

39. **Question:** *“Is the GC allowed to utilize the existing heat and cooling equipment for the last few months of the project?”*

Response: The use of the permanent HVAC system is allowed provided that acceptable filter media is installed, and the contractor agrees to clean the system if it is soiled.

40. **Question:** *“Can you please confirm whether or not the GC is responsible for including cost for a full-time, on-site superintendent/supervision?”*

Response: Full time site supervision is required.

41. **Question:** “In the “exterior finish carpentry” specification, 3 manufacturers are listed, and none of them are Accoya. Is Accoya intended to be listed here? Also, a 50 year warranty is specified, which 2 of the 3 manufacturers do not manufacture products with those certain parameters. Is Accoya intended to be the only product that is applicable for this spec section?”

Response: The basis-of-design manufacturer and product is indicated on Sheet A221. Additional manufacturers with the specified warranty have been added to revised Specification Section 06 2013 “Exterior Finish Carpentry,” though the other manufacturers have indicated they would provide a special warranty upon request.

42. **Question:** “Is the emergency generator, concrete pad in the base bid or alternate #6?”

Response: The pad shall be provided as part of the Alternate.

SUBSTITUTION REQUESTS

1. Section: 07 41 13.16 “Standing-Seam Metal Roof Panels”
Manufacturer: Construction Metal Products (CMP) of Statesville, NC
Product: S-2500 Panel

Disposition: Approved.

2. Lighting Fixtures

Disposition:

Fixture L Substitution: Ledalite #29-0-3-L-930-15-NQ-16-D-E-1. Approved.

Fixture LE Substitution: Ledalite #29-0-3-L-930-15-NQ-16-D-E-1-B. Approved.

Fixture M Substitution: Not approved. Fixture requires indirect and direct lighting.

SPECIFICATIONS (attached)

06 2013 - EXTERIOR FINISH CARPENTRY
074113.16 - STANDING-SEAM METAL ROOF PANELS
074213.13 - FORMED METAL WALL PANELS
074293 - SOFFIT PANELS
083513.13 - MULTIPANEL FOLDING ALUMINUM-FRAMED GLASS DOORS
260519 - LOW-VOLTAGE ELECTRICAL POWER CONDUCTORS AND CABLES
260543 - UNDERGROUND DUCTS AND RACEWAYS FOR ELECTRICAL SYSTEMS
262726 - WIRING DEVICES
263214 - ENGINE GENERATORS - DIESEL-ENGINE-DRIVEN GENERATOR
284621.11 - ADDRESSABLE FIRE-ALARM SYSTEMS

DRAWINGS (attached)

A112
A221
A 503
A701
E101
E102
E111

E507

-- END OF ADDENDUM NO. 2 --

SECTION 062013 - EXTERIOR FINISH CARPENTRY

PART 1 - GENERAL

1.1 SUMMARY

- A. Section Includes:
1. Engineered wood siding.
 2. Engineered wood soffits.

1.2 ACTION SUBMITTALS

- A. Product Data: For each type of process and factory-fabricated product.
- B. Samples: For each exposed product and for each color and texture specified.

1.3 WARRANTY

- A. Manufacturer's Warranty for Engineered Wood Siding Soffits and Trim: Manufacturer agrees to repair or replace components that fail in materials or workmanship within specified warranty period.
1. Warranty Period for Siding, Soffits, and Trim : 50 years from date of Final Completion.

PART 2 - PRODUCTS

2.1 ENGINEERED WOOD SIDING

- A. Manufacturers: Subject to compliance with requirements, provide products by one of the following:
1. reSAWN TIMBER Company.
 2. Nakamoto Forestry
 3. Thermory USA
 4. ***Accsys**
- B. Engineered Wood Siding:
1. Type:
 - a. 3/4-inch- thick by 6-inch- wide tongue and groove siding.
- C. Colors, Textures, and Patterns: As indicated by manufacturer's designations.

- D. Colors, Textures, and Patterns: As indicated by manufacturer's designations.

2.2 ENGINEERED WOOD SOFFITS

- A. Manufacturers: Subject to compliance with requirements, provide products by one of the following:

1. reSAWN TIMBER Company.
2. Nakamoto Forestry
3. Thermory USA
4. *Accsys

- B. Engineered Wood Soffits:

1. Type: 3/4-inch- thick tongue and groove.
2. Colors, Textures, and Patterns: As indicated by manufacturer's designations.

2.3 MISCELLANEOUS MATERIALS

- A. Fasteners for Exterior Finish Carpentry: Provide nails or screws, in sufficient length to penetrate not less than 1-1/2 inches into metal framing substrate.

1. For face-fastening siding, provide fasteners recommended in writing by manufacturer.

- B. Sealants: Latex, complying with ASTM C834 Type OP, Grade NF and applicable requirements in Section 079200 "Joint Sealants," and recommended by sealant and substrate manufacturers for intended application.

1. Manufacturers: Subject to compliance with requirements, available manufacturers offering products that may be incorporated into the Work include, but are not limited to, the following:
 - a. Bostik, Inc.
 - b. Franklin International.
 - c. Pecora Corporation.
 - d. Permthane®/Acryl-R®; ITW Polymers Sealants North America.
 - e. Tremco, Inc.

PART 3 - EXECUTION

3.1 PREPARATION

- A. Clean substrates of projections and substances detrimental to application.

3.2 INSTALLATION, GENERAL

- A. Install exterior finish carpentry level, plumb, true, and aligned with adjacent materials.
 - 1. Use concealed shims where necessary for alignment.
 - 2. Scribe and cut exterior finish carpentry to fit adjoining work.
 - 3. Refinish and seal cuts as recommended by manufacturer.
 - 4. Install to tolerance of 1/8 inch in 96 inches for level and plumb. Install adjoining exterior finish carpentry with 1/32-inch maximum offset for flush installation and 1/16-inch maximum offset for reveal installation.
 - 5. Coordinate exterior finish carpentry with materials and systems in or adjacent to it.
 - 6. Provide cutouts for mechanical and electrical items that penetrate exterior finish carpentry.

3.3 INSTALLATION OF SIDING

- A. Install siding to comply with manufacturer's written instructions and warranty requirements.
- B. Engineered Wood Siding:
 - 1. Install engineered wood siding to comply with manufacturer's written instructions.
 - 2. Install panels with edges over framing.
 - 3. Leave 3/16-inch gap at perimeter, openings, and horizontal panel joints unless otherwise recommended by panel manufacturer.
 - 4. Seal butt joints at inside and outside corners and at trim locations.
 - 5. Install continuous metal flashing at horizontal panel joints.
 - 6. Apply battens and corner trim as indicated.
 - 7. Conceal fasteners to greatest practical extent by placing in grooves of siding pattern or by concealing with applied trim or battens as detailed.
- C. Finish: Apply finish within two weeks of installation.

END OF SECTION

SECTION 074113.16 - STANDING-SEAM METAL ROOF PANELS

PART 1 - GENERAL

1.1 SUMMARY

A. Section Includes:

1. Standing-seam metal roof panels.

1.2 PREINSTALLATION MEETINGS

- A. Preinstallation Conference: Conduct conference at Project site.

1.3 ACTION SUBMITTALS

- A. Product Data: For each type of product.
- B. Sustainable Design Submittals:
 1. Product Data: For recycled content, indicating postconsumer and preconsumer recycled content and cost.
- C. Shop Drawings: Include fabrication and installation layouts of metal panels; details of edge conditions, joints, panel profiles, corners, anchorages, attachment system, trim, flashings, closures, and accessories; and special details.
- D. Samples: For each type of metal panel and each color indicated.

1.4 INFORMATIONAL SUBMITTALS

- A. Product test reports.
- B. Warranties: Sample of special warranties.

1.5 CLOSEOUT SUBMITTALS

- A. Maintenance data.

1.6 QUALITY ASSURANCE

- A. Installer Qualifications: An entity that employs installers and supervisors who are trained and approved by manufacturer.

- B. UL-Certified, Portable Roll-Forming Equipment: UL-certified, portable roll-forming equipment capable of producing metal panels warranted by manufacturer to be the same as factory-formed products. Maintain UL certification of portable roll-forming equipment for duration of work.

1.7 WARRANTY

- A. Special Warranty: Installer's standard form in which installer agrees to repair or replace components of metal panel systems that fail in workmanship within specified warranty period.
 - 1. Warranty Period: Five years from date of Final Completion.
- B. Special Warranty on Panel Finishes: Manufacturer's standard form in which manufacturer agrees to repair finish or replace metal panels that show evidence of deterioration of factory-applied finishes within specified warranty period.
 - 1. Finish Warranty Period: 20 years from date of Final Completion.
- C. Special Weathertightness Warranty: Manufacturer's standard form in which manufacturer agrees to repair or replace standing-seam metal roof panel assemblies that fail to remain weathertight, including leaks, within specified warranty period.
 - 1. Warranty Period: 20 years from date of Final Completion.

PART 2 - PRODUCTS

2.1 PERFORMANCE REQUIREMENTS

- A. Recycled Content: Postconsumer recycled content plus one-half of preconsumer recycled content not less than 25 percent.
- B. Structural Performance: Provide metal panel systems capable of withstanding the effects of the following loads, based on testing according to ASTM E1592:
 - 1. Wind Loads: As indicated on Drawings.
 - 2. Other Design Loads: As indicated on Drawings.
 - 3. Deflection Limits: For wind loads, no greater than 1/240 of the span.
- C. Air Infiltration: Air leakage of not more than 0.06 cfm/sq. ft. when tested according to ASTM E1680 at the following test-pressure difference:
 - 1. Test-Pressure Difference: 6.24 lbf/sq. ft..
- D. Water Penetration under Static Pressure: No water penetration when tested according to ASTM E1646 at the following test-pressure difference:
 - 1. Test-Pressure Difference: 6.24 lbf/sq. ft..

- E. Hydrostatic-Head Resistance: No water penetration when tested according to ASTM E2140.
- F. Wind-Uplift Resistance: Provide metal roof panel assemblies that comply with UL 580 for wind-uplift-resistance class indicated.
 - 1. Uplift Rating: UL 60.
- G. Thermal Movements: Allow for thermal movements from ambient and surface temperature changes by preventing buckling, opening of joints, overstressing of components, failure of joint sealants, failure of connections, and other detrimental effects. Base calculations on surface temperatures of materials due to both solar heat gain and nighttime-sky heat loss.
 - 1. Temperature Change (Range): 120 deg F, ambient; 180 deg F, material surfaces.

2.2 STANDING-SEAM METAL ROOF PANELS

- A. Provide factory-formed metal roof panels designed to be installed by lapping and interconnecting raised side edges of adjacent panels with joint type indicated and mechanically attaching panels to supports using concealed clips in side laps. Include clips, cleats, pressure plates, and accessories required for weathertight installation.
 - 1. Steel Panel Systems: Unless more stringent requirements are indicated, comply with ASTM E1514.
- B. Vertical-Rib, Seamed-Joint, Standing-Seam Metal Roof Panels : Formed with vertical ribs at panel edges and intermediate stiffening ribs symmetrically spaced between ribs; designed for sequential installation by mechanically attaching panels to supports using concealed clips located under one side of panels, engaging opposite edge of adjacent panels, and mechanically seaming panels together.
 - 1. Manufacturers: Subject to compliance with requirements, provide products by one of the following:
 - a. CENTRIA, a Nucor Brand.
 - b. Firestone Building Products.
 - c. Metal Roofing Systems, Inc.
 - d. PAC-CLAD; Petersen Aluminum Corporation; a Carlisle company.
 - 2. Metallic-Coated Steel Sheet: Zinc-coated (galvanized) steel sheet complying with ASTM A653/A653M, G90 coating designation, or aluminum-zinc alloy-coated steel sheet complying with ASTM A792/A792M, Class AZ50 coating designation; structural quality. Prepainted by the coil-coating process to comply with ASTM A755/A755M.
 - a. Nominal Thickness: ~~*0.052 in.~~ **24 gauge**.
 - b. Exterior Finish: Two-coat fluoropolymer.
 - c. Color: As indicated by manufacturer's designations.

3. Clips: One-piece fixed to accommodate thermal movement.
4. Material:
 - a. 0.028-inch- nominal thickness, zinc-coated (galvanized) or aluminum-zinc alloy-coated steel sheet.
5. Joint Type: Double folded.
6. Panel Coverage: 24 **18** inches.
7. Panel Height: 1.5 inches.

2.3 UNDERLAYMENT MATERIALS

- A. Self-Adhering, High-Temperature Underlayment: Provide self-adhering, cold-applied, sheet underlayment, a minimum of 30 mils thick, consisting of slip-resistant, polyethylene-film top surface laminated to a layer of butyl or SBS-modified asphalt adhesive, with release-paper backing. Provide primer when recommended by underlayment manufacturer.
1. Thermal Stability: Stable after testing at 240 deg F; ASTM D1970.
 2. Low-Temperature Flexibility: Passes after testing at minus 20 deg F; ASTM D1970.
 3. Manufacturers: Subject to compliance with requirements, provide products by one of the following:
 - a. ATAS International, Inc.
 - b. Carlisle WIP Products; a brand of Carlisle Construction Materials.
 - c. GCP Applied Technologies Inc.
 - d. Henry Company.
 - e. Owens Corning.
- B. Slip Sheet: Manufacturer's recommended slip sheet, of type required for application.

2.4 MISCELLANEOUS MATERIALS

- A. Miscellaneous Metal Subframing and Furring: ASTM C645; cold-formed, metallic-coated steel sheet, ASTM A653/A653M, G90 hot-dip galvanized coating designation or ASTM A792/A792M, Class AZ50 coating designation unless otherwise indicated. Provide manufacturer's standard sections as required for support and alignment of metal panel system.
- B. Panel Accessories: Provide components required for a complete, weathertight panel system including trim, copings, fasciae, mullions, sills, corner units, clips, flashings, sealants, gaskets, fillers, closure strips, and similar items. Match material and finish of metal panels unless otherwise indicated.
1. Closures: Provide closures at eaves and ridges, fabricated of same metal as metal panels.
 2. Backing Plates: Provide metal backing plates at panel end splices, fabricated from material recommended by manufacturer.

3. Closure Strips: Closed-cell, expanded, cellular, rubber or crosslinked, polyolefin-foam or closed-cell laminated polyethylene; minimum 1-inch- thick, flexible closure strips; cut or premolded to match metal panel profile. Provide closure strips where indicated or necessary to ensure weathertight construction.
- C. Flashing and Trim: Provide flashing and trim formed from same material as metal panels as required to seal against weather and to provide finished appearance. Locations include, but are not limited to, eaves, rakes, corners, bases, framed openings, ridges, fasciae, and fillers. Finish flashing and trim with same finish system as adjacent metal panels.
- D. Gutters and Downspouts: Formed from same material as roof panels according to SMACNA's "Architectural Sheet Metal Manual." Finish to match metal roof panels.
- E. Panel Fasteners: Self-tapping screws designed to withstand design loads.
- F. Panel Sealants: Provide sealant type recommended by manufacturer that are compatible with panel materials, are nonstaining, and do not damage panel finish.
 1. Butyl-Rubber-Based, Solvent-Release Sealant: ASTM C1311.

2.5 FABRICATION

- A. Fabricate and finish metal panels and accessories at the factory, by manufacturer's standard procedures and processes, as necessary to fulfill indicated performance requirements demonstrated by laboratory testing. Comply with indicated profiles and with dimensional and structural requirements.
- B. On-Site Fabrication: Subject to compliance with requirements of this Section, metal panels may be fabricated on-site using UL-certified, portable roll-forming equipment if panels are of same profile and warranted by manufacturer to be equal to factory-formed panels. Fabricate according to equipment manufacturer's written instructions and to comply with details shown.
- C. Provide panel profile, including major ribs and intermediate stiffening ribs, if any, for full length of panel.
- D. Fabricate metal panel joints with factory-installed captive gaskets or separator strips that provide a weathertight seal and prevent metal-to-metal contact, and that minimize noise from movements.
- E. Sheet Metal Flashing and Trim: Fabricate flashing and trim to comply with manufacturer's recommendations and recommendations in SMACNA's "Architectural Sheet Metal Manual" that apply to design, dimensions, metal, and other characteristics of item indicated.

2.6 FINISHES

- A. Panels and Accessories:

1. Two-Coat Fluoropolymer: AAMA 621. Fluoropolymer finish containing not less than 70 percent polyvinylidene fluoride (PVDF) resin by weight in color coat.
2. Concealed Finish: White or light-colored acrylic or polyester backer finish.

PART 3 - EXECUTION

3.1 PREPARATION

- A. Miscellaneous Supports: Install subframing, furring, and other miscellaneous panel support members and anchorages according to ASTM C754 and metal panel manufacturer's written recommendations.

3.2 INSTALLATION OF UNDERLAYMENT

- A. Self-Adhering Sheet Underlayment: Apply primer if required by manufacturer. Comply with temperature restrictions of underlayment manufacturer for installation. Apply at locations indicated on Drawings, wrinkle free, in shingle fashion to shed water, and with end laps of not less than 6 inches staggered 24 inches between courses. Overlap side edges not less than 3-1/2 inches. Roll laps with roller. Cover underlayment within 14 days.
 1. Apply over the entire roof surface.
- B. Flashings: Install flashings to cover underlayment to comply with requirements specified in Section 076200 "Sheet Metal Flashing and Trim."

3.3 INSTALLATION OF STANDING-SEAM METAL ROOF PANELS

- A. Standing-Seam Metal Roof Panel Installation: Fasten metal roof panels to supports with concealed clips at each standing-seam joint at location, spacing, and with fasteners recommended in writing by manufacturer.
 1. Install clips to supports with self-tapping fasteners.
 2. Install pressure plates at locations indicated in manufacturer's written installation instructions.
 3. Seamed Joint: Crimp standing seams with manufacturer-approved, motorized seamer tool so clip, metal roof panel, and factory-applied sealant are completely engaged.
 4. Watertight Installation:
 - a. Apply a continuous ribbon of sealant or tape to seal joints of metal panels, using sealant or tape as recommend in writing by manufacturer as needed to make panels watertight.
 - b. Provide sealant or tape between panels and protruding equipment, vents, and accessories.
 - c. At panel splices, nest panels with minimum 6-inch end lap, sealed with sealant and fastened together by interlocking clamping plates.

- B. Accessory Installation: Install accessories with positive anchorage to building and weathertight mounting, and provide for thermal expansion. Coordinate installation with flashings and other components.
- C. Flashing and Trim: Comply with performance requirements, manufacturer's written installation instructions, and SMACNA's "Architectural Sheet Metal Manual." Provide concealed fasteners where possible, and set units true to line and level as indicated. Install work with laps, joints, and seams that will be permanently watertight and weather resistant.

3.4 CLEANING AND PROTECTION

- A. Remove temporary protective coverings and strippable films, if any, as metal panels are installed, unless otherwise indicated in manufacturer's written installation instructions. On completion of metal panel installation, clean finished surfaces as recommended by metal panel manufacturer. Maintain in a clean condition during construction.

END OF SECTION

SECTION 074213.13 - FORMED METAL WALL PANELS

PART 1 - GENERAL

1.1 SUMMARY

A. Section Includes:

1. Concealed-fastener, lap-seam metal wall panels.

1.2 PREINSTALLATION MEETINGS

- A. Preinstallation Conference: Conduct conference at Project site.

1.3 ACTION SUBMITTALS

- A. Product Data: For each type of product.

B. Sustainable Design Submittals:

1. Product Data: For recycled content, indicating postconsumer and preconsumer recycled content and cost.

- C. Shop Drawings: Include fabrication and installation layouts of metal panels; details of edge conditions, joints, panel profiles, corners, anchorages, attachment system, trim, flashings, closures, and accessories; and special details.

- D. Samples: For each type of metal panel indicated.

1.4 QUALITY ASSURANCE

- A. Installer Qualifications: An entity that employs installers and supervisors who are trained and approved by manufacturer.

1.5 WARRANTY

- A. Special Warranty: Manufacturer's standard form in which manufacturer agrees to repair or replace components of metal panel systems that fail in materials or workmanship within specified warranty period.

1. Warranty Period: Two years from date of Final Completion.

- B. Special Warranty on Panel Finishes: Manufacturer's standard form in which manufacturer agrees to repair finish or replace metal panels that show evidence of deterioration of factory-applied finishes within specified warranty period.

1. Finish Warranty Period: 20 years from date of Final Completion.

PART 2 - PRODUCTS

2.1 PERFORMANCE REQUIREMENTS

- A. Recycled Content: Postconsumer recycled content plus one-half of preconsumer recycled content not less than 25 percent.
- B. Structural Performance: Provide metal panel systems capable of withstanding the effects of the following loads, based on testing according to ASTM E1592:
 1. Wind Loads: As indicated on Drawings.
 2. Other Design Loads: As indicated on Drawings.
 3. Deflection Limits: For wind loads, no greater than 1/240 of the span.
- C. Air Infiltration: Air leakage of not more than 0.06 cfm/sq. ft. when tested according to ASTM E283 at the following test-pressure difference:
 1. Test-Pressure Difference: 6.24 lbf/sq. ft..
- D. Water Penetration under Static Pressure: No water penetration when tested according to ASTM E331 at the following test-pressure difference:
 1. Test-Pressure Difference: 6.24 lbf/sq. ft..
- E. Thermal Movements: Allow for thermal movements from ambient and surface temperature changes by preventing buckling, opening of joints, overstressing of components, failure of joint sealants, failure of connections, and other detrimental effects. Base calculations on surface temperatures of materials due to both solar heat gain and nighttime-sky heat loss.
 1. Temperature Change (Range): 120 deg F, ambient; 180 deg F, material surfaces.

2.2 CONCEALED-FASTENER, LAP-SEAM METAL WALL PANELS

- A. Provide factory-formed metal panels designed to be field assembled by lapping and interconnecting side edges of adjacent panels and mechanically attaching through panel to supports using concealed fasteners and factory-applied sealant in side laps. Include accessories required for weathertight installation.
- B. Reveal-Joint, Concealed-Fastener Metal Wall Panels : Formed with vertical panel edges and a flat pan between panel edges; with narrow reveal joint between panels.
 1. Manufacturers: Subject to compliance with requirements, provide products by one of the following:
 - a. CENTRIA, a Nucor Brand
 - b. Morin - A Kingspan Group Company.

- c. ***Metal Roofing Systems, Inc.**
 - d. PAC-CLAD; Petersen Aluminum Corporation; a Carlisle company.
2. Metallic-Coated Steel Sheet: Zinc-coated (galvanized) steel sheet complying with ASTM A653/A653M, G90 coating designation, or aluminum-zinc alloy-coated steel sheet complying with ASTM A792/A792M, Class AZ50 coating designation; structural quality. Prepainted by the coil-coating process to comply with ASTM A755/A755M.
- a. Nominal Thickness: 22 gage.
 - b. Exterior Finish: Two-coat fluoropolymer.
 - c. Color: As indicated by manufacturer's designations.

2.3 MISCELLANEOUS MATERIALS

- A. Miscellaneous Metal Subframing and Furring: ASTM C645, cold-formed, metallic-coated steel sheet, ASTM A653/A653M, G90 hot-dip galvanized coating designation or ASTM A792/A792M, Class AZ50 aluminum-zinc-alloy coating designation unless otherwise indicated. Provide manufacturer's standard sections as required for support and alignment of metal panel system.
- B. Panel Accessories: Provide components required for a complete, weathertight panel system including trim, copings, fasciae, mullions, sills, corner units, clips, flashings, sealants, gaskets, fillers, closure strips, and similar items. Match material and finish of metal panels unless otherwise indicated.
 - 1. Closures: Provide closures at eaves and rakes, fabricated of same metal as metal panels.
 - 2. Backing Plates: Provide metal backing plates at panel end splices, fabricated from material recommended by manufacturer.
 - 3. Closure Strips: Closed-cell, expanded, cellular, rubber or crosslinked, polyolefin-foam or closed-cell laminated polyethylene; minimum 1-inch- thick, flexible closure strips; cut or premolded to match metal panel profile. Provide closure strips where indicated or necessary to ensure weathertight construction.
- C. Flashing and Trim: Provide flashing and trim formed from same material as metal panels as required to seal against weather and to provide finished appearance. Locations include, but are not limited to, bases, drips, sills, jambs, corners, endwalls, framed openings, rakes, fasciae, parapet caps, soffits, reveals, and fillers. Finish flashing and trim with same finish system as adjacent metal panels.
- D. Panel Fasteners: Self-tapping screws designed to withstand design loads. Provide exposed fasteners with heads matching color of metal panels by means of plastic caps or factory-applied coating. Provide EPDM or PVC sealing washers for exposed fasteners.
- E. Panel Sealants: Provide sealant type recommended by manufacturer that are compatible with panel materials, are nonstaining, and do not damage panel finish.
 - 1. Butyl-Rubber-Based, Solvent-Release Sealant: ASTM C1311.

2.4 FABRICATION

- A. Fabricate and finish metal panels and accessories at the factory, by manufacturer's standard procedures and processes, as necessary to fulfill indicated performance requirements demonstrated by laboratory testing. Comply with indicated profiles and with dimensional and structural requirements.
- B. Provide panel profile, including major ribs and intermediate stiffening ribs, if any, for full length of panel.
- C. Fabricate metal panel joints with factory-installed captive gaskets or separator strips that provide a weathertight seal and prevent metal-to-metal contact, and that minimize noise from movements.
- D. Sheet Metal Flashing and Trim: Fabricate flashing and trim to comply with manufacturer's recommendations and recommendations in SMACNA's "Architectural Sheet Metal Manual" that apply to design, dimensions, metal, and other characteristics of item indicated.

2.5 FINISHES

- A. Panels and Accessories:
 - 1. Two-Coat Fluoropolymer: AAMA 621. Fluoropolymer finish containing not less than 70 percent polyvinylidene fluoride (PVDF) resin by weight in color coat.
 - 2. Concealed Finish: White or light-colored acrylic or polyester backer finish.

PART 3 - EXECUTION

3.1 PREPARATION

- A. Miscellaneous Supports: Install subframing, furring, and other miscellaneous panel support members and anchorages according to ASTM C754 and metal panel manufacturer's written recommendations.

3.2 INSTALLATION

- A. Lap-Seam Metal Panels: Fasten metal panels to supports with fasteners at each lapped joint at location and spacing recommended by manufacturer.
 - 1. Lap ribbed or fluted sheets one full rib. Apply panels and associated items true to line for neat and weathertight enclosure.
 - 2. Provide metal-backed washers under heads of exposed fasteners bearing on weather side of metal panels.
 - 3. Install screw fasteners with power tools having controlled torque adjusted to compress washer tightly without damage to washer, screw threads, or panels. Install screws in predrilled holes.
 - 4. Flash and seal panels with weather closures at perimeter of all openings.

- B. Watertight Installation:
1. Apply a continuous ribbon of sealant or tape to seal lapped joints of metal panels, using sealant or tape as recommend by manufacturer on side laps of nesting-type panels; and elsewhere as needed to make panels watertight.
 2. Provide sealant or tape between panels and protruding equipment, vents, and accessories.
 3. At panel splices, nest panels with minimum 6-inch end lap, sealed with sealant and fastened together by interlocking clamping plates.
- C. Accessory Installation: Install accessories with positive anchorage to building and weathertight mounting, and provide for thermal expansion. Coordinate installation with flashings and other components.
- D. Flashing and Trim: Comply with performance requirements, manufacturer's written installation instructions, and SMACNA's "Architectural Sheet Metal Manual." Provide concealed fasteners where possible, and set units true to line and level as indicated. Install work with laps, joints, and seams that are permanently watertight.

3.3 CLEANING

- A. Remove temporary protective coverings and strippable films, if any, as metal panels are installed, unless otherwise indicated in manufacturer's written installation instructions. On completion of metal panel installation, clean finished surfaces as recommended by metal panel manufacturer. Maintain in a clean condition during construction.

END OF SECTION

SECTION 074293 - SOFFIT PANELS

PART 1 - GENERAL

1.1 SUMMARY

A. Section Includes:

1. Metal soffit panels.

1.2 PREINSTALLATION MEETINGS

- A. Preinstallation Conference: Conduct conference at Project site.

1.3 ACTION SUBMITTALS

- A. Product Data: For each type of product.
- B. Shop Drawings: Include fabrication and installation layouts of metal panels; details of edge conditions, joints, panel profiles, corners, anchorages, attachment system, trim, flashings, closures, and accessories; and special details.
- C. Samples: For each type of metal panel indicated.

1.4 INFORMATIONAL SUBMITTALS

- A. Warranties: Samples of special warranties.

1.5 WARRANTY

- A. Special Warranty: Manufacturer's standard form in which manufacturer agrees to repair or replace components of metal panel systems that fail in materials or workmanship within specified warranty period.
 1. Warranty Period: Two years from date of Final Completion.
- B. Special Warranty on Panel Finishes: Manufacturer's standard form in which manufacturer agrees to repair finish or replace metal panels that show evidence of deterioration of factory-applied finishes within specified warranty period.
 1. Finish Warranty Period: 20 years from date of Final Completion.

PART 2 - PRODUCTS

2.1 PERFORMANCE REQUIREMENTS

- A. Recycled Content: Postconsumer recycled content plus one-half of preconsumer recycled content not less than 25 percent.
- B. Structural Performance: Provide metal panel systems capable of withstanding the effects of the following loads, based on testing according to ASTM E1592:
 - 1. Wind Loads: As indicated on Drawings.
 - 2. Other Design Loads: As indicated on Drawings.
 - 3. Deflection Limits: For wind loads, no greater than 1/240 of the span.
- C. Air Infiltration: Air leakage of not more than 0.06 cfm/sq. ft. when tested according to ASTM E283 at the following test-pressure difference:
 - 1. Test-Pressure Difference: 6.24 lbf/sq. ft..
- D. Water Penetration under Static Pressure: No water penetration when tested according to ASTM E331 at the following test-pressure difference:
 - 1. Test-Pressure Difference: 6.24 lbf/sq. ft..
- E. Thermal Movements: Allow for thermal movements from ambient and surface temperature changes by preventing buckling, opening of joints, overstressing of components, failure of joint sealants, failure of connections, and other detrimental effects. Base calculations on surface temperatures of materials due to both solar heat gain and nighttime-sky heat loss.
 - 1. Temperature Change (Range): 120 deg F, ambient; 180 deg F, material surfaces.

2.2 METAL SOFFIT PANELS

- A. Provide metal soffit panels designed to be installed by lapping and interconnecting side edges of adjacent panels and mechanically attaching through panel to supports using concealed fasteners in side laps. Include accessories required for weathertight installation.
- B. Metal Soffit Panels: Match profile and material of metal roof panels.
 - 1. Finish: Match finish and color of metal roof panels.
 - 2. Sealant: Factory applied within interlocking joint.
- C. Reveal-Joint-Profile Metal Soffit Panels : Solid panels formed with vertical panel edges and a flat pan between panel edges; with recessed reveal joint between panels.
 - 1. Manufacturers: Subject to compliance with requirements, provide products by one of the following:

- a. Firestone Building Products.
 - b. Firestone Metal Products.
 - c. ***Metal Roofing Systems, Inc.**
 - d. PAC-CLAD; Petersen Aluminum Corporation; a Carlisle company.
2. Material: Same material, finish, and color as metal roof panels.
 3. Panel Coverage: 12 inches.
 4. Panel Height: 0.75 inch.

2.3 MISCELLANEOUS MATERIALS

- A. Miscellaneous Metal Subframing and Furring: ASTM C645, cold-formed, metallic-coated steel sheet, ASTM A653/A653M, G90 hot-dip galvanized coating designation or ASTM A792/A792M, Class AZ50 aluminum-zinc-alloy coating designation unless otherwise indicated. Provide manufacturer's standard sections as required for support and alignment of metal panel system.
- B. Panel Accessories: Provide components required for a complete, weathertight panel system including trim, clips, flashings, sealants, gaskets, fillers, closure strips, and similar items. Match material and finish of metal panels unless otherwise indicated.
 1. Closure Strips: Closed-cell, expanded, cellular, rubber or crosslinked, polyolefin-foam or closed-cell laminated polyethylene; minimum 1-inch- thick, flexible closure strips; cut or premolded to match metal panel profile. Provide closure strips where indicated or necessary to ensure weathertight construction.
- C. Flashing and Trim: Provide flashing and trim formed from same material as metal panels as required to seal against weather and to provide finished appearance. Finish flashing and trim with same finish system as adjacent metal panels.
- D. Panel Fasteners: Self-tapping screws designed to withstand design loads. Provide exposed fasteners with heads matching color of metal panels by means of plastic caps or factory-applied coating. Provide EPDM or PVC sealing washers for exposed fasteners.
- E. Panel Sealants: Provide sealant types recommended by manufacturer that are compatible with panel materials, are nonstaining, and do not damage panel finish.
 1. Butyl-Rubber-Based, Solvent-Release Sealant: ASTM C1311.

2.4 FABRICATION

- A. Fabricate and finish metal panels and accessories at the factory, by manufacturer's standard procedures and processes, as necessary to fulfill indicated performance requirements demonstrated by laboratory testing. Comply with indicated profiles and with dimensional and structural requirements.

- B. Provide panel profile, including major ribs and intermediate stiffening ribs, if any, for full length of panel.
- C. Fabricate metal panel joints with factory-installed captive gaskets or separator strips that provide a weathertight seal and prevent metal-to-metal contact, and that minimize noise from movements.
- D. Sheet Metal Flashing and Trim: Fabricate flashing and trim to comply with manufacturer's recommendations and recommendations in SMACNA's "Architectural Sheet Metal Manual" that apply to design, dimensions, metal, and other characteristics of item indicated.

2.5 FINISHES

- A. Panels and Accessories:
 - 1. Two-Coat Fluoropolymer: AAMA 621. Fluoropolymer finish containing not less than 70 percent polyvinylidene fluoride (PVDF) resin by weight in color coat. Prepare, pretreat, and apply coating to exposed metal surfaces to comply with coating and resin manufacturers' written instructions.

PART 3 - EXECUTION

3.1 PREPARATION

- A. Miscellaneous Supports: Install subframing, furring, and other miscellaneous panel support members and anchorages according to ASTM C754 and metal panel manufacturer's written recommendations.
 - 1. Soffit Framing: Wire tie or clip furring channels to supports, as required to comply with requirements for assemblies indicated.

3.2 INSTALLATION

- A. Metal Soffit Panels: Fasten metal panels to supports with fasteners at each lapped joint at location and spacing recommended by manufacturer.
 - 1. Apply panels and associated items true to line for neat and weathertight enclosure.
 - 2. Provide metal-backed washers under heads of exposed fasteners bearing on weather side of metal panels.
 - 3. Locate and space exposed fasteners in uniform vertical and horizontal alignment. Use proper tools to obtain controlled uniform compression for positive seal without rupture of washer.
 - 4. Install screw fasteners with power tools having controlled torque adjusted to compress washer tightly without damage to washer, screw threads, or panels. Install screws in predrilled holes.

B. Watertight Installation:

1. Apply a continuous ribbon of sealant or tape to seal lapped joints of metal panels, using sealant or tape as recommend by manufacturer on side laps of nesting-type panels and elsewhere as needed to make panels watertight.
2. Provide sealant or tape between panels and protruding equipment, vents, and accessories.
3. At panel splices, nest panels with minimum 6-inch end lap, sealed with sealant and fastened together by interlocking clamping plates.

C. Accessory Installation: Install accessories with positive anchorage to building and weathertight mounting, and provide for thermal expansion. Coordinate installation with flashings and other components.

D. Flashing and Trim: Comply with performance requirements, manufacturer's written installation instructions, and SMACNA's "Architectural Sheet Metal Manual." Provide concealed fasteners where possible, and set units true to line and level as indicated. Install work with laps, joints, and seams that are permanently watertight.

3.3 CLEANING

- A. Remove temporary protective coverings and strippable films, if any, as metal panels are installed unless otherwise indicated in manufacturer's written installation instructions. On completion of metal panel installation, clean finished surfaces as recommended by metal panel manufacturer. Maintain in a clean condition during construction.

END OF SECTION

SECTION 083513.13 - MULTIPANEL FOLDING ALUMINUM-FRAMED GLASS DOORS

PART 1 - GENERAL

1.1 SUMMARY

A. Section Includes:

1. Multipanel folding aluminum-framed glass doors.

B. Related Requirements:

1. Section 012300 "Alternates" for multipanel folding aluminum-framed glass doors provided as an alternate.

1.2 ACTION SUBMITTALS

A. Product Data:

1. Multipanel folding aluminum-framed glass doors.

B. Shop Drawings:

1. Include plans, elevations, sections, and installation details.
2. Indicate dimensions, configuration of panels, and stacking layout.

C. Samples: For each multipanel folding aluminum-framed glass door and for each color specified.

1.3 CLOSEOUT SUBMITTALS

A. Maintenance data.

1.4 QUALITY ASSURANCE

A. Installer Qualifications: An installer acceptable to multipanel folding aluminum-framed glass door manufacturer for installation of units required for this Project.

1.5 WARRANTY

A. Manufacturer's Special Warranty: Manufacturer agrees to repair or replace multipanel folding aluminum-framed glass doors that fail(s) in materials or workmanship within specified warranty period.

1. Warranty Period:

- a. Multipanel Folding Aluminum-Framed Glass Doors: 20 year(s) from date of Final Completion.
 - b. Insulating-Glass Units: 10 years from date of Final Completion.
 - c. Laminated Glass: Five years from date of Final Completion.
 - d. Aluminum Finish: 20 years from date of Final Completion.
- B. Special Finish Warranty, Anodized Finishes: Standard form in which manufacturer agrees to repair finishes or replace aluminum that shows evidence of deterioration of anodized finishes within specified warranty period.
1. Warranty Period: 10 years from date of Final Completion.

PART 2 - PRODUCTS

2.1 MANUFACTURERS

- A. Manufacturers: Subject to compliance with requirements, provide products by one of the following:
1. C.R. Laurence Co., Inc.; CRH Americas, Inc.
 2. Euro-Wall Systems, LLC.
 3. Nana Wall Systems, Inc.

2.2 PERFORMANCE REQUIREMENTS

- A. Product Standard: Comply with AAMA/WDMA/CSA 101/I.S.2/A440 for minimum standards of performance, materials, components, accessories, and fabrication unless more stringent requirements are indicated.
1. Product Certification: AAMA certified with label attached to each door.
- B. Performance Class and Grade: AAMA/WDMA/CSA 101/I.S.2/A440 as follows:
1. Minimum Performance Class: Class AW.
 2. Minimum Performance Grade: Grade 40 .

2.3 MULTIPANEL FOLDING ALUMINUM-FRAMED GLASS DOORS

- A. Multipanel Folding Aluminum-Framed Glass Doors: Provide extruded-aluminum-framed multipanel folding glass doors, complete with glazing, threshold, flashings, support, and anchorage devices.
1. Application: Interior, outward opening.
 2. Stack Storage Configuration: As shown on Drawings.

- B. Frames and Door Panels: Fabricated from aluminum extrusions complying with AAMA/WDMA/CSA 101/I.S.2/A440. Provide factory-assembled door panels that are reglazable without dismantling panel framing, and factory-assembled frames.

- 1. Door Panel Design: Narrow stile design, with 10-inch nominal height bottom rail.

2.4 GLAZING

- A. Glass and Glazing: Manufacturer's standard glazing system that produces weathertight seal. Comply with requirements indicated in Section 088000 "Glazing".

2.5 HARDWARE

- A. Provide manufacturer's standard hardware, fabricated from a corrosion-resistant material compatible with door panels and other components, and complying with AAMA 907. Provide hardware designed to smoothly operate, tightly close, and securely lock multipanel folding aluminum-framed glass doors. Size hardware to accommodate panel weights and dimensions. Provide full-perimeter weatherstripping for each door panel.
- B. Refer to Section 087100 "Door Hardware" for hardware for doors.
- C. Panel Support System: Provide panel support system designed for size, weight, and performance requirements of multipanel folding aluminum-framed glass doors indicated. Provide carriers with sealed ball bearings.
 - 1. Overhead Supported: Provide multiwheeled overhead carriers suspended from steel or aluminum track, with lower guide system engaged in threshold for smooth operation. Limit track deflection to no more than 0.10 inch between supports when fully loaded.
 - 2. Adjustment: Provide panel support system capable of being adjusted for smooth operation and clearances without needing to remove panels from tracks.
 - 3. Threshold Configuration: Extruded-aluminum threshold with recessed flush profile.
 - a. Aluminum Finish: To match panel.
- D. Panel Hinges: Stainless steel, multileaf hinge with painted finish to match exterior. Provide integral hangers and guides for hinges that engage panel support system.

2.6 |ACCESSORIES

- A. Trim: Provide interior and exterior casings, jamb extensions, and other components in material and finish to match door frames.

2.7 FABRICATION

- A. Complete fabrication, assembly, finishing, hardware application, and other work in the factory to greatest extent possible. Disassemble components only as necessary for shipment and installation.

2.8 GENERAL FINISH REQUIREMENTS

- A. Appearance of Finished Work: Noticeable variations in same piece are unacceptable. Variations in appearance of adjoining components are acceptable if they are within the range of approved Samples and are assembled or installed to minimize contrast.

2.9 ALUMINUM FINISHES

- A. ***Clear Anodic Finish: AAMA 611, AA-M12C22A41, Class I, 0.018 mm or thicker.**
- B. ~~Color Anodic Finish: AAMA 611, AA-M12C22A42/A44, Class I, 0.018 mm or thicker.~~
 - 1. ~~Color: As selected by Architect from full range of industry colors and color densities.~~

PART 3 - EXECUTION

3.1 INSTALLATION

- A. Comply with Drawings, Shop Drawings, and manufacturer's written instructions for installing multipanel folding aluminum-framed glass doors, hardware, accessories, and other components.
- B. Install multipanel folding aluminum-framed glass doors level, plumb, square, true to line; without distortion, warp, or rack of frames and panels, and without impeding thermal movement; anchored securely in place to structural support; and in proper relation to wall flashing, vapor retarders, air barriers, water/weather barriers, and other adjacent construction.
- C. Set threshold members in bed of sealant or with gaskets, as indicated, to provide weathertight construction.
- D. Separate aluminum and other corrodible surfaces from sources of corrosion or electrolytic action at points of contact with other materials.

3.2 ADJUSTING

- A. Adjust hardware for proper alignment, smooth operation, and proper latching without unnecessary force or excessive clearance.
- B. Adjust hardware and operable panels to function smoothly, and lubricate as recommended by manufacturer.

END OF SECTION

SECTION 260519 - LOW-VOLTAGE ELECTRICAL POWER CONDUCTORS AND CABLES

PART 1 - GENERAL

1.1 RELATED DOCUMENTS

- A. Drawings and general provisions of the Contract, including General and Supplementary Conditions and Division 01 Specification Sections, apply to this Section.

1.2 SUMMARY

- A. Section Includes:
 - 1. Copper building wire.
 - 2. Fire-alarm wire and cable.
 - 3. Connectors and splices.

1.3 DEFINITIONS

- A. RoHS: Restriction of Hazardous Substances.
- B. VFC: Variable-frequency controller.

1.4 ACTION SUBMITTALS

- A. Product Data: For each type of product.
- B. Product Schedule: Indicate type, use, location, and termination locations.

1.5 INFORMATIONAL SUBMITTALS

- A. Qualification Data: For testing agency.
- B. Field quality-control reports.

1.6 QUALITY ASSURANCE

- A. Testing Agency Qualifications: Member company of NETA.
 - 1. Testing Agency's Field Supervisor: Certified by NETA to supervise on-site testing.
 - 2. Power conductors and cables shall be listed by an approved third-party testing agency accredited by the North Carolina Building Code Council (<https://www.ncosfm.gov/third-party-testing-agencies/open>)

PART 2 - PRODUCTS

2.1 COPPER BUILDING WIRE

- A. Description: Flexible, insulated and uninsulated, drawn copper current-carrying conductor with an overall insulation layer or jacket, or both, rated 600 V or less.
- B. Manufacturers: Subject to compliance with requirements, available manufacturers offering products that may be incorporated into the Work include, but are not limited to the following:
1. Alpha Wire; brand of Belden, Inc.
 2. Belden Inc.
 3. Cerro Wire LLC.
 4. Encore Wire Corporation.
 5. General Cable; Prysmian Group North America.
 6. Okonite Company (The).
 7. Service Wire Co.
 8. Southwire Company, LLC.
 9. WESCO.
- C. Standards:
1. Listed and labeled as defined in NFPA 70, by a qualified testing agency, and marked for intended location and use.
 2. RoHS compliant.
 3. Conductor and Cable Marking: Comply with wire and cable marking according to UL's "Wire and Cable Marking and Application Guide."
- D. Conductors: Copper, complying with ASTM B3 for bare annealed copper and with ASTM B8 for stranded conductors.
- E. Conductor Insulation:
1. Type THHN and Type THWN-2: Comply with UL 83.
 2. Type XHHW-2: Comply with UL 44.

2.2 FIRE-ALARM WIRE AND CABLE

- A. Manufacturers: Subject to compliance with requirements, available manufacturers offering products that may be incorporated into the Work include, but are not limited to the following:
1. Allied Wire & Cable Inc.
 2. CommScope, Inc.
 3. Comtran Corporation.
 4. Genesis; Resideo Technologies, Inc.
 5. PYROTENAX; brand of nVent Electrical plc.
 6. Prysmian Cables and Systems; Prysmian Group North America.
 7. Radix Wire.

8. Rockbestos-Suprenant Cable Corp.
 9. Superior Essex Inc.; subsidiary of LS Corp.
 10. West Penn Wire; brand of Belden, Inc.
 11. Cerro Wire LLC.
- B. General Wire and Cable Requirements: NRTL listed and labeled as complying with NFPA 70, Article 760.
- C. Signaling Line Circuits: Twisted, shielded pair, not less than No. 18 AWG.
1. Circuit Integrity Cable: Twisted shielded pair, NFPA 70, Article 760, Classification CI, for power-limited fire-alarm signal service Type FPL. NRTL listed and labeled as complying with UL 1424 and UL 2196 for a two-hour rating.
- D. Non-Power-Limited Circuits: Solid-copper conductors with 600-V rated, 75 deg C, color-coded insulation, and complying with requirements in UL 2196 for a two-hour rating.
1. Low-Voltage Circuits: No. 16 AWG, minimum, in pathway.
 2. Line-Voltage Circuits: No. 12 AWG, minimum, in pathway.
 3. ~~*Multiconductor Armored Cable: NFPA 70, Type MC, copper conductors, Type TFN/THHN conductor insulation, copper drain wire, copper armor with outer jacket with red identifier stripe, NRTL listed for fire alarm and cable tray installation, plenum rated.~~

2.3 CONNECTORS AND SPLICES

- A. Description: Factory-fabricated connectors, splices, and lugs of size, ampacity rating, material, type, and class for application and service indicated; listed and labeled as defined in NFPA 70, by a qualified testing agency, and marked for intended location and use.
- B. Manufacturers: Subject to compliance with requirements, available manufacturers offering products that may be incorporated into the Work include, but are not limited to the following:
1. 3M Electrical Products.
 2. ABB, Electrification Business.
 3. AFC Cable Systems; Atkore International.
 4. Gardner Bender.
 5. Hubbell Utility Solutions; Hubbell Incorporated.
 6. ILSCO.
 7. Ideal Industries, Inc.
 8. NSi Industries LLC.
 9. O-Z/Gedney; brand of Emerson Electric Co., Automation Solutions, Appleton Group.
 10. Service Wire Co.
 11. TE Connectivity Ltd.
 12. Burndy; brand of Hubbell Electrical Solutions; Hubbell Incorporated.
- C. Jacketed Cable Connectors: For steel and aluminum jacketed cables, zinc die-cast with set screws, designed to connect conductors specified in this Section.
- D. Lugs: One piece, seamless, designed to terminate conductors specified in this Section.
1. Material: Copper.

2. Type: One hole with standard barrels.
3. Termination: Compression.

PART 3 - EXECUTION

3.1 CONDUCTOR MATERIAL APPLICATIONS

A. Feeders:

1. Copper; solid for No. 10 AWG and smaller; stranded for No. 8 AWG and larger.
2. Copper for feeders smaller than No. 4 AWG; copper or aluminum for feeders No. 4 AWG and larger.
Conductors shall be solid for No. 10 AWG and smaller; stranded for No. 8 AWG and larger.

B. Branch Circuits:

1. Copper. Solid for No. 10 AWG and smaller; stranded for No. 8 AWG and larger.
2. Copper. Solid for No. 12 AWG and smaller; stranded for No. 10 AWG and larger.

C. VFC Output Circuits Cable: Extra-flexible stranded for all sizes.

D. Power-Limited Fire Alarm and Control: Solid for No. 12 AWG and smaller.

3.2 CONDUCTOR INSULATION AND MULTICONDUCTOR CABLE APPLICATIONS AND WIRING METHODS

A. Service Entrance: Type THHN/THWN-2, single conductors in raceway or Type XHHW-2, single conductors in raceway.

B. Exposed Feeders: Type THHN/THWN-2, single conductors in raceway, or Type XHHW-2, single conductors in raceway.

C. Feeders Concealed in Ceilings, Walls, Partitions, and Crawlspace: Type THHN/THWN-2, single conductors in raceway* ~~or Metal-clad cable, Type MC.~~

D. Feeders Concealed in Concrete, below Slabs-on-Grade, and Underground: Type THHN/THWN-2, single conductors in raceway or Type XHHW-2, single conductors in raceway.

E. Branch Circuits Concealed in Ceilings, Walls, and Partitions: Type THHN/THWN-2, single conductors in raceway *~~or Metal-clad cable, Type MC.~~

F. Branch Circuits Concealed in Concrete, below Slabs-on-Grade, and Underground: Type THHN/THWN-2, single conductors in raceway or Type XHHW-2, single conductors in raceway.

3.3 INSTALLATION, GENERAL

A. Conceal cables in finished walls, ceilings, and floors unless otherwise indicated.

- B. Complete raceway installation between conductor and cable termination points according to Section 260533 "Raceways and Boxes for Electrical Systems" prior to pulling conductors and cables.
- C. Use manufacturer-approved pulling compound or lubricant where necessary; compound used must not deteriorate conductor or insulation. Do not exceed manufacturer's recommended maximum pulling tensions and sidewall pressure values.
- D. Use pulling means, including fish tape, cable, rope, and basket-weave wire/cable grips, that will not damage cables or raceway.
- E. Install exposed cables parallel and perpendicular to surfaces of exposed structural members, and follow surface contours where possible.
- F. Support cables according to Section 260529 "Hangers and Supports for Electrical Systems."
- G. Complete cable tray systems installation according to Section 260536 "Cable Trays for Electrical Systems" prior to installing conductors and cables.

3.4 INSTALLATION OF FIRE-ALARM WIRE AND CABLE

- A. Comply with NECA 1 and NFPA 72.
- B. Wiring Method: Install wiring in metal pathway according to Section 270528.29 "Hangers and Supports for Communications Systems."
 - 1. Install plenum cable in environmental airspaces, including plenum ceilings.
 - 2. Fire-alarm circuits and equipment control wiring associated with fire-alarm system shall be installed in a dedicated pathway system.
 - a. Cables and pathways used for fire-alarm circuits, and equipment control wiring associated with fire-alarm system, may not contain any other wire or cable.
 - 3. Fire-Rated Cables: Use of two-hour, fire-rated fire-alarm cables, NFPA 70, Types MI and CI, is not permitted.
 - 4. Signaling Line Circuits: Power-limited fire-alarm cables shall not be installed in the same cable or pathway as signaling line circuits.
- C. Wiring within Enclosures: Separate power-limited and non-power-limited conductors as recommended by manufacturer. Install conductors parallel with or at right angles to sides and back of the enclosure. Bundle, lace, and train conductors to terminal points with no excess. Connect conductors that are terminated, spliced, or interrupted in any enclosure associated with fire-alarm system to terminal blocks. Mark each terminal according to system's wiring diagrams. Make all connections with approved crimp-on terminal spade lugs, pressure-type terminal blocks, or plug connectors.
- D. Cable Taps: Use numbered terminal strips in junction, pull, and outlet boxes; cabinets; or equipment enclosures where circuit connections are made.

- E. Color-Coding: Color-code fire-alarm conductors differently from the normal building power wiring. Use one color-code for alarm circuit wiring and another for supervisory circuits. Color-code audible alarm-indicating circuits differently from alarm-initiating circuits. Use different colors for visible alarm-indicating devices. Paint fire-alarm system junction boxes and covers red.
- F. Risers: Install at least two vertical cable risers to serve the fire-alarm system. Separate risers in close proximity to each other with a minimum one-hour-rated wall, so the loss of one riser does not prevent receipt or transmission of signals from other floors or zones.
- G. Wiring to Remote Alarm Transmitting Device: 1-inch conduit between the fire-alarm control panel and the transmitter. Install number of conductors and electrical supervision for connecting wiring as needed to suit monitoring function.

3.5 CONNECTIONS

- A. Tighten electrical connectors and terminals according to manufacturer's published torque-tightening values. If manufacturer's torque values are not indicated, use those specified in UL 486A-486B.
- B. Make splices, terminations, and taps that are compatible with conductor material.
 - 1. Use oxide inhibitor in each splice, termination, and tap for aluminum conductors.
- C. Wiring at Outlets: Install conductor at each outlet, with at least [6 inches] [12 inches] of slack.
- D. Comply with requirements in Section 284621.11 "Addressable Fire-Alarm Systems" for connecting, terminating, and identifying wires and cables.

3.6 IDENTIFICATION

- A. Identify and color-code conductors and cables according to Section 260553 "Identification for Electrical Systems."
- B. Identify each spare conductor at each end with identity number and location of other end of conductor, and identify as spare conductor.

3.7 SLEEVE AND SLEEVE-SEAL INSTALLATION FOR ELECTRICAL PENETRATIONS

- A. Install sleeves and sleeve seals at penetrations of exterior floor and wall assemblies. Comply with requirements in Section 260544 "Sleeves and Sleeve Seals for Electrical Raceways and Cabling."

3.8 FIRESTOPPING

- A. Apply firestopping to electrical penetrations of fire-rated floor and wall assemblies to restore original fire-resistance rating of assembly according to Section 078413 "Penetration Firestopping."

3.9 FIELD QUALITY CONTROL

A. Administrant for Tests and Inspections:

1. Owner will engage qualified testing agency to administer and perform tests and inspections.
2. Engage qualified testing agency to administer and perform tests and inspections.
3. Engage factory-authorized service representative to administer and perform tests and inspections on components, assemblies, and equipment installations, including connections.
4. Administer and perform tests and inspections with assistance of factory-authorized service representative.

B. Tests and Inspections:

1. After installing conductors and cables and before electrical circuitry has been energized, test service entrance and feeder conductors for compliance with requirements.
2. Perform each of the following visual and electrical tests:
 - a. Inspect exposed sections of conductor and cable for physical damage and correct connection according to the single-line diagram.
 - b. Test bolted connections for high resistance using one of the following:
 - 1) A low-resistance ohmmeter.
 - 2) Calibrated torque wrench.
 - 3) Thermographic survey.
 - c. Inspect compression-applied connectors for correct cable match and indentation.
 - d. Inspect for correct identification.
 - e. Inspect cable jacket and condition.
 - f. Insulation-resistance test on each conductor for ground and adjacent conductors. Apply a potential of 500-V dc for 300-V rated cable and 1000-V dc for 600-V rated cable for a one-minute duration.
 - g. Continuity test on each conductor and cable.
 - h. Uniform resistance of parallel conductors.
3. Initial Infrared Scanning: After Final Acceptance, but before Final Acceptance, perform an infrared scan of each splice in conductors No. 3 AWG and larger. Remove box and equipment covers so splices are accessible to portable scanner. Correct deficiencies determined during the scan.
 - a. Instrument: Use an infrared scanning device designed to measure temperature or to detect significant deviations from normal values. Provide calibration record for device.
 - b. Record of Infrared Scanning: Prepare a certified report that identifies switches checked and that describes scanning results. Include notation of deficiencies detected, remedial action taken, and observations after remedial action.
4. Follow-up Infrared Scanning: Perform an additional follow-up infrared scan of each switch 11 months after date of Final Acceptance.

C. Cables will be considered defective if they do not pass tests and inspections.

D. Prepare test and inspection reports to record the following:

1. Procedures used.
2. Results that comply with requirements.
3. Results that do not comply with requirements, and corrective action taken to achieve compliance with requirements.

END OF SECTION

SECTION 260543 - UNDERGROUND DUCTS AND RACEWAYS FOR ELECTRICAL SYSTEMS

PART 1 - GENERAL

1.1 RELATED DOCUMENTS

- A. Drawings and general provisions of the Contract, including General and Supplementary Conditions and Division 01 Specification Sections, apply to this Section.

1.2 SUMMARY

- A. Section Includes:

1. Metal conduits and fittings, including GRC and PVC-coated steel conduit.
2. Rigid nonmetallic duct.
3. Flexible nonmetallic duct.
4. Duct accessories.
5. Precast concrete handholes.
6. Polymer concrete handholes and boxes with polymer concrete cover.
7. Precast manholes.
8. Cast-in-place manholes.
9. Utility structure accessories.

1.3 DEFINITIONS

- A. Direct Buried: Duct or a duct bank that is buried in the ground, without any additional casing materials such as concrete.
- B. Duct: A single duct or multiple ducts. Duct may be either installed singly or as component of a duct bank.
- C. Duct Bank:
 1. Two or more ducts installed in parallel, with or without additional casing materials.
 2. Multiple duct banks.
- D. GRC: Galvanized rigid (steel) conduit.
- E. Trafficways: Locations where vehicular or pedestrian traffic is a normal course of events.

1.4 ACTION SUBMITTALS

- A. Product Data: For each type of product.
 1. Include duct-bank materials, including spacers and miscellaneous components.

2. Include duct, conduits, and their accessories, including elbows, end bells, bends, fittings, and solvent cement.
3. Include accessories for manholes, handholes, boxes.
4. Include underground-line warning tape.
5. Include warning planks.

B. Shop Drawings:

1. Precast or Factory-Fabricated Underground Utility Structures:

- a. Include plans, elevations, sections, details, attachments to other work, and accessories.
- b. Include duct entry provisions, including locations and duct sizes.
- c. Include reinforcement details.
- d. Include frame and cover design and manhole chimneys.
- e. Include ladder details.
- f. Include grounding details.
- g. Include dimensioned locations of cable rack inserts, pulling-in and lifting irons, and sumps.
- h. Include joint details.

2. Factory-Fabricated Handholes and Boxes Other Than Precast Concrete:

- a. Include dimensioned plans, sections, and elevations, and fabrication and installation details.
- b. Include duct entry provisions, including locations and duct sizes.
- c. Include cover design.
- d. Include grounding details.
- e. Include dimensioned locations of cable rack inserts, and pulling-in and lifting irons.

1.5 INFORMATIONAL SUBMITTALS

- A. Coordination Drawings: For duct and duct bank. Show duct profiles and coordination with other utilities and underground structures.
 1. Include plans and sections, drawn to scale, and show bends and locations of expansion fittings.
 2. Drawings shall be signed and sealed by a qualified professional engineer.
- B. Qualification Data: For professional engineer and testing agency responsible for testing nonconcrete handholes and boxes.
- C. Product Certificates: For concrete and steel used in precast concrete manholes and handholes, as required by ASTM C858.
- D. Source quality-control reports.
- E. Field quality-control reports.

1.6 MAINTENANCE MATERIALS SUBMITTALS

- A. Furnish extra materials that match products installed and that are packaged with protective covering for storage and identified with labels describing contents.
- B. Furnish cable-support stanchions, arms, insulators, and associated fasteners in quantities equal to 5 percent of quantity of each item installed.

1.7 QUALITY ASSURANCE

- A. Testing Agency Qualifications: Qualified according to ASTM E329 for testing indicated.

1.8 FIELD CONDITIONS

- A. Ground Water: Assume ground-water level is at grade level unless a lower water table is noted on Drawings.
- B. Ground Water: Assume ground-water level is 36 inches below ground surface unless a higher water table is noted on Drawings.

PART 2 - PRODUCTS

2.1 METAL CONDUIT AND FITTINGS

- A. GRC: Comply with ANSI C80.1 and UL 6.
- B. Coated Steel Conduit: PVC-coated GRC or IMC.
 - 1. Comply with NEMA RN 1.
 - 2. Coating Thickness: 0.040 inch, minimum.
- C. Manufacturers: Subject to compliance with requirements, available manufacturers offering products that may be incorporated into the Work include, but are not limited to the following:
 - 1. Excellerate.
- D. Listed and labeled as defined in NFPA 70, by a nationally recognized testing laboratory, and marked for intended location and application.

2.2 RIGID NONMETALLIC DUCT

- A. Underground Plastic Utilities Duct: Type EPC-40-PVC RNC, complying with NEMA TC 2 and UL 651, with matching fittings complying with NEMA TC 3 by same manufacturer as duct.
- B. Listed and labeled as defined in NFPA 70, by a nationally recognized testing laboratory, and marked for intended location and application.

- C. Solvents and Adhesives: As recommended by conduit manufacturer.

2.3 FLEXIBLE NONMETALLIC DUCTS

- A. HDPE Duct: Type EPEC-40 HDPE, complying with NEMA TC 7 and UL 651A.

1. Listed and labeled as defined in NFPA 70, by a nationally recognized testing laboratory, and marked for intended location and application.

2.4 DUCT ACCESSORIES

- A. Duct Spacers: Factory-fabricated, rigid, PVC interlocking spacers; sized for type and size of duct with which used, and selected to provide minimum duct spacing indicated while supporting duct during concreting or backfilling.

1. Manufacturers: Subject to compliance with requirements, available manufacturers offering products that may be incorporated into the Work include, but are not limited to the following:

- a. ABB, Electrification Business.
- b. Allied Tube & Conduit; Atkore International.
- c. Cantex Inc.
- d. IPEX USA LLC.
- e. PenCell Plastics; brand of Hubbell Utility Solutions; Hubbell Incorporated.
- f. Underground Devices, Inc.

- B. Underground-Line Warning Tape: Comply with requirements for underground-line warning tape specified in Section 260553 "Identification for Electrical Systems."

- C. Concrete Warning Planks: Nominal 12 by 24 by 3 inches in size, manufactured from 6000-psi concrete.

1. Color: Red dye added to concrete during batching.
2. Mark each plank with "ELECTRIC" in 2-inch- high, 3/8-inch- deep letters.

2.5 POLYMER CONCRETE HANDHOLES AND BOXES WITH POLYMER CONCRETE COVER

- A. Description: Molded of sand and aggregate, bound together with a polymer resin, and reinforced with steel or fiberglass or a combination of the two.

- B. <Manufacturers: Subject to compliance with requirements, available manufacturers offering products that may be incorporated into the Work include, but are not limited to the following:

1. Armorcast Products Company; brand of Hubbell Utility Solutions; Hubbell Incorporated.
2. MacLean Highline.
3. NewBasis.
4. Oldcastle Infrastructure Inc.; CRH Americas.
5. Quazite; brand of Hubbell Utility Solutions; Hubbell Incorporated.

- C. Standard: Comply with SCTE 77. Comply with tier requirements in "Underground Enclosure Application" Article.
- D. Color: Gray.
- E. Configuration: Units shall be designed for flush burial and have closed bottom unless otherwise indicated.
- F. Cover: Weatherproof, secured by tamper-resistant locking devices and having structural load rating consistent with enclosure.
- G. Cover Finish: Nonskid finish shall have a minimum coefficient of friction of 0.50.
- H. Cover Legend: Molded lettering, "ELECTRIC." as indicated for each service.
- I. Direct-Buried Wiring Entrance Provisions: Knockouts equipped with insulated bushings or end-bell fittings, selected to suit box material, sized for wiring indicated, and arranged for secure, fixed installation in enclosure wall.
- J. Duct Entrance Provisions: Duct-terminating fittings shall mate with entering duct for secure, fixed installation in enclosure wall.
- K. Handholes 12 inches wide by 24 inches long and larger shall have factory-installed inserts for cable racks and pulling-in irons.

2.6 SOURCE QUALITY CONTROL

- A. Test and inspect precast concrete utility structures according to ASTM C1037.
- B. Nonconcrete Handhole and Pull-Box Prototype Test: Test prototypes of manholes and boxes for compliance with SCTE 77. Strength tests shall be for specified tier ratings of products supplied.
 - 1. Tests of materials shall be performed by an independent testing agency.
 - 2. Strength tests of complete boxes and covers shall be by an independent testing agency or manufacturer. A qualified registered professional engineer shall certify tests by manufacturer.
 - 3. Testing machine pressure gages shall have current calibration certification, complying with ISO 9000 and ISO 10012, and traceable to NIST standards.

PART 3 - EXECUTION

3.1 PREPARATION

- A. Coordinate layout and installation of duct, duct bank, manholes, handholes, and boxes with final arrangement of other utilities, site grading, and surface features as determined in the field. Notify Architect if there is a conflict between areas of excavation and existing structures or archaeological sites to remain.

- B. Coordinate elevations of duct and duct-bank entrances into manholes, handholes, and boxes with final locations and profiles of duct and duct banks, as determined by coordination with other utilities, underground obstructions, and surface features. Revise locations and elevations as required to suit field conditions and to ensure that duct and duct bank will drain to manholes and handholes, and as approved by Architect.
- C. Clear and grub vegetation to be removed, and protect vegetation to remain according to Section 311000 "Site Clearing." Remove and stockpile topsoil for reapplication according to Section 311000 "Site Clearing."

3.2 UNDERGROUND DUCT APPLICATION

- A. Duct for Electrical Cables More Than 600 V: Type EPC-40-PVC RNC, concrete-encased unless otherwise indicated.
- B. Duct for Electrical Feeders 600 V and Less: Type EPC-40-PVC RNC, concrete-encased unless otherwise indicated.
- C. Duct for Electrical Feeders 600 V and Less: Type EPC-40-PVC RNC, ~~*direct-buried-unless otherwise indicated-concrete-encased unless otherwise indicated.~~
- D. Duct for Electrical Branch Circuits: Type EPC-40-PVC RNC, direct-buried unless otherwise indicated.
- E. ***Duct for Telecommunication Cable: Type EPC-40-PVC RNC, concrete-encased unless otherwise indicated.**
- F. Bored Underground Duct: Type EPEC-40-HDPE unless otherwise indicated.
- G. Underground Ducts Crossing Paved Paths, Walks and Driveways, Roadways: Type EPC-40 PVC RNC, encased in reinforced concrete.
- H. Stub-ups: Concrete-encased GRC.

3.3 UNDERGROUND ENCLOSURE APPLICATION

- A. Handholes and Boxes for 600 V and Less:
 - 1. Units in Roadways and Other Deliberate Traffic Paths: Precast concrete, AASHTO HB 17, H-10 structural load rating.
 - 2. Units in Driveway, Parking Lot, and Off-Roadway Locations, Subject to Occasional, Non-deliberate Loading by Heavy Vehicles: Precast concrete, AASHTO HB 17, H-20 structural load rating.
 - 3. Units in Sidewalk and Similar Applications with a Safety Factor for Nondeliberate Loading by Vehicles: Precast concrete, AASHTO HB 17, H-10 structural load rating.
 - 4. Units Subject to Light-Duty Pedestrian Traffic Only: Fiberglass-reinforced polyester resin, structurally tested according to SCTE 77 with 3000-lbf vertical loading.
 - 5. Cover design load shall not exceed the design load of the handhole or box.

B. Manholes: Precast concrete.

1. Units Located in Roadways and Other Deliberate Traffic Paths by Heavy or Medium Vehicles: H-20 structural load rating according to AASHTO HB 17.
2. Units Not Located in Deliberate Traffic Paths by Heavy or Medium Vehicles: H-10 load rating according to AASHTO HB 17.

3.4 EARTHWORK

- A. Excavation and Backfill: Comply with Section 312000 "Earth Moving," but do not use heavy-duty, hydraulic-operated, compaction equipment.
- B. Restoration: Replace area immediately after backfilling is completed or after construction vehicle traffic in immediate area is complete.
- C. Restore surface features at areas disturbed by excavation, and re-establish original grades unless otherwise indicated. Replace removed sod immediately after backfilling is completed.
- D. Restore areas disturbed by trenching, storing of dirt, cable laying, and other work. Restore vegetation and include necessary topsoiling, fertilizing, liming, seeding, sodding, sprigging, and mulching. Comply with Section 329200 "Turf and Grasses" and Section 329300 "Plants."
- E. Cut and patch existing pavement in the path of underground duct, duct bank, and underground structures according to "Cutting and Patching" Article in Section 017300 "Execution."

3.5 DUCT AND DUCT-BANK INSTALLATION

- A. Where indicated on Drawings, install duct, spacers, and accessories into the duct-bank configuration shown. Duct installation requirements in this Section also apply to duct bank.
- B. Install duct according to NEMA TCB 2.
- C. Slope: Pitch duct a minimum slope of 1:300 down toward manholes and handholes and away from buildings and equipment. Slope duct from a high point between two manholes, to drain in both directions.
- D. Curves and Bends: Use 5-degree angle couplings for small changes in direction. Use manufactured long sweep bends with a minimum radius of [48 inches] [12.5 feet] [25 feet], both horizontally and vertically, at other locations unless otherwise indicated.
 1. Duct shall have maximum of two 90 degree bends or the total of all bends shall be no more 180 degrees between pull points.
- E. Joints: Use solvent-cemented joints in duct and fittings and make watertight according to manufacturer's written instructions. Stagger couplings so those of adjacent duct do not lie in same plane.

- F. Installation Adjacent to High-Temperature Steam Lines: Where duct is installed parallel to underground steam lines, perform calculations showing the duct will not be subject to environmental temperatures above 40 deg C. Where environmental temperatures are calculated to rise above 40 deg C, and anywhere the duct crosses above an underground steam line, install insulation blankets listed for direct burial to isolate the duct bank from the steam line.
- G. End Bell Entrances to Manholes and Concrete and Polymer Concrete Handholes: Use end bells, spaced approximately 10 inches o.c. for 5-inch duct, and vary proportionately for other duct sizes.
- 1.Begin change from regular spacing to end-bell spacing 10 feet from the end bell, without reducing duct slope and without forming a trap in the line.
 - 2.Expansion and Deflection Fittings: Install an expansion and deflection fitting in each duct in the area of disturbed earth adjacent to manhole or handhole. Install an expansion fitting near the center of all straight line direct-buried duct with calculated expansion of more than 3/4 inch.
 - 3.Grout end bells into structure walls from both sides to provide watertight entrances.
- H. Terminator Entrances to Manholes and Concrete and Polymer Concrete Handholes: Use manufactured, cast-in-place duct terminators, with entrances into structure spaced approximately 6 inches o.c. for 4-inch duct, and vary proportionately for other duct sizes.
- 1.Begin change from regular spacing to terminator spacing 10 feet from the terminator, without reducing duct line slope and without forming a trap in the line.
 - 2.Expansion and Deflection Fittings: Install an expansion and deflection fitting in each duct in the area of disturbed earth adjacent to manhole or handhole. Install an expansion fitting near the center of all straight line duct with calculated expansion of more than 3/4 inch.
- I. Building Wall Penetrations: Make a transition from underground duct to GRC at least 10 feet outside the building wall, without reducing duct line slope away from the building and without forming a trap in the line. Use fittings manufactured for RNC-to-GRC transition. Install GRC penetrations of building walls as specified in Section 260544 "Sleeves and Sleeve Seals for Electrical Raceways and Cabling."
- J. Sealing: Provide temporary closure at terminations of duct with pulled cables. Seal spare duct at terminations. Use sealing compound and plugs to withstand at least 15-psig hydrostatic pressure.
- K. Pulling Cord: Install 200-lbf- test nylon cord in empty ducts.
- L. Concrete-Encased Ducts and Duct Bank:
- 1.Excavate trench bottom to provide firm and uniform support for duct. Prepare trench bottoms as specified in Section 312000 "Earth Moving" for pipes less than 6 inches in nominal diameter.
 - 2.Width: Excavate trench 12 inches wider than duct on each side.
 - 3.Width: Excavate trench 3 inches wider than duct on each side.
 - 4.Depth: Install so top of duct envelope is at least 24 inches below finished grade in areas not subject to deliberate traffic, and at least 30 inches below finished grade in deliberate traffic paths for vehicles unless otherwise indicated.

5. Support duct on duct spacers coordinated with duct size, duct spacing, and outdoor temperature.
6. Spacer Installation: Place spacers close enough to prevent sagging and deforming of duct, with not less than four spacers per 20 feet of duct. Place spacers within 24 inches of duct ends. Stagger spacers approximately 6 inches between tiers. Secure spacers to earth and to duct to prevent floating during concreting. Tie entire assembly together using fabric straps; do not use tie wires or reinforcing steel that may form conductive or magnetic loops around ducts or duct groups.
7. Minimum Space between Duct: 3 inches between edge of duct and exterior envelope wall, 2 inches between ducts for like services, and 4 inches between power and communications ducts.
8. Elbows: Use manufactured duct elbows for stub-ups, at building entrances, and at changes of direction in duct unless otherwise indicated. Extend encasement throughout length of elbow.
9. Elbows: Use manufactured GRC elbows for stub-ups, at building entrances, and at changes of direction in duct run.
 - a. Couple RNC duct to GRC with adapters designed for this purpose, and encase coupling with 3 inches of concrete.
 - b. Stub-ups to Outdoor Equipment: Extend concrete-encased GRC horizontally a minimum of 60 inches from edge of base. Install insulated grounding bushings on terminations at equipment.
 - 1) Stub-ups shall be minimum 4 inches above finished floor and minimum 3 inches from conduit side to edge of slab
 - c. Stub-ups to Indoor Equipment: Extend concrete-encased GRC horizontally a minimum of 60 inches from edge of wall. Install insulated grounding bushings on terminations at equipment.
 - 1) Stub-ups shall be minimum 4 inches above finished floor and no less than 3 inches from conduit side to edge of slab
10. Reinforcement: Reinforce concrete-encased duct where crossing disturbed earth and where indicated. Arrange reinforcing rods and ties without forming conductive or magnetic loops around ducts or duct groups.
11. Forms: Use walls of trench to form side walls of duct bank where soil is self-supporting and concrete envelope can be poured without soil inclusions; otherwise, use forms.
12. Concrete Cover: Install a minimum of 3 inches of concrete cover between edge of duct to exterior envelope wall, 2 inches between duct of like services, and 4 inches between power and communications ducts.
13. Concreting Sequence: Pour each run of envelope between manholes or other terminations in one continuous operation.
 - a. Start at one end and finish at the other, allowing for expansion and contraction of duct as its temperature changes during and after the pour. Use expansion fittings installed according to manufacturer's written instructions, or use other specific measures to prevent expansion-contraction damage.
 - b. If more than one pour is necessary, terminate each pour in a vertical plane and install 3/4-inch reinforcing-rod dowels extending a minimum of 18 inches into concrete on both sides of joint near corners of envelope.

14. Pouring Concrete: Comply with requirements in "Concrete Placement" Article in Section 033000 "Cast-in-Place Concrete." Place concrete carefully during pours to prevent voids under and between duct and at exterior surface of envelope. Do not allow a heavy mass of concrete to fall directly onto ducts. Allow concrete to flow around duct and rise up in middle, uniformly filling all open spaces. Do not use power-driven agitating equipment unless specifically designed for duct-installation application.

M. Direct-Buried Duct and Duct Bank:

1. Excavate trench bottom to provide firm and uniform support for duct. Comply with requirements in Section 312000 "Earth Moving" for preparation of trench bottoms for pipes less than 6 inches in nominal diameter.
2. Width: Excavate trench 12 inches wider than duct on each side.
3. Width: Excavate trench 3 inches wider than duct on each side.
4. Depth: Install top of duct at least 36 inches below finished grade unless otherwise indicated.
5. Set elevation of bottom of duct bank below frost line.
6. Support ducts on duct spacers coordinated with duct size, duct spacing, and outdoor temperature.
7. Spacer Installation: Place spacers close enough to prevent sagging and deforming of duct, with not less than four spacers per 20 feet of duct. Place spacers within 24 inches of duct ends. Stagger spacers approximately 6 inches between tiers. Secure spacers to earth and to ducts to prevent floating during concreting. Tie entire assembly together using fabric straps; do not use tie wires or reinforcing steel that may form conductive or magnetic loops around ducts or duct groups.
8. Install duct with a minimum of 3 inches between ducts for like services and 6 inches between power and communications duct.
9. Elbows: Install manufactured duct elbows for stub-ups, at building entrances, and at changes of direction in duct direction unless otherwise indicated. Encase elbows for stub-up ducts throughout length of elbow.
10. Install manufactured GRC elbows for stub-ups, at building entrances, and at changes of direction in duct.
 - a. Couple RNC duct to GRC with adapters designed for this purpose, and encase coupling with 3 inches of concrete.
 - b. Stub-ups to Outdoor Equipment: Extend concrete-encased GRC horizontally a minimum of 60 inches from edge of base. Install insulated grounding bushings on terminations at equipment.
 - 1) Stub-ups shall be minimum 4 inches above finished floor and minimum 3 inches from conduit side to edge of slab
 - c. Stub-ups to Indoor Equipment: Extend concrete-encased GRC horizontally a minimum of 60 inches from edge of wall. Install insulated grounding bushings on terminations at equipment.
 - 1) Stub-ups shall be minimum 4 inches above finished floor and no less than 3 inches from conduit side to edge of slab

11. After installing first tier of duct, backfill and compact. Start at tie-in point and work toward end of duct run, leaving ducts at end of run free to move with expansion and contraction as temperature changes during this process. Repeat procedure after placing each tier. After placing last tier, hand place backfill to 4 inches over duct and hand tamp. Firmly tamp backfill around ducts to provide maximum supporting strength. Use hand tamper only. After placing controlled backfill over final tier, make final duct connections at end of run and complete backfilling with normal compaction. Comply with requirements in Section 312000 "Earth Moving" for installation of backfill materials.
 - a. Place minimum 3 inches of sand as a bed for duct. Place sand to a minimum of 6 inches above top level of duct.
 - b. Place minimum 6 inches of engineered fill above concrete encasement of duct.
- N. Warning Planks: Bury warning planks approximately 12 inches above direct-buried duct, placing them 24 inches o.c. Align planks along the width and along the centerline of duct or duct bank. Provide an additional plank for each 12-inch increment of duct-bank width over a nominal 18 inches. Space additional planks 12 inches apart, horizontally.
- O. Underground-Line Warning Tape: Bury conducting underground line specified in Section 260553 "Identification for Electrical Systems" no less than 12 inches above all concrete-encased duct and approximately 6-8 inches below grade. Align tape parallel to and within 3 inches of centerline of duct bank. Provide an additional warning tape for each 12-inch increment of duct-bank width over a nominal 18 inches. Space additional tapes 12 inches apart, horizontally.

3.6 INSTALLATION OF CONCRETE MANHOLES, HANDHOLES, AND BOXES

A. Cast-in-Place Manhole Installation:

1. Finish interior surfaces with a smooth-troweled finish.
2. Knockouts for Future Duct Connections: Form and pour concrete knockout panels 1-1/2 to 2 inches thick, arranged as indicated.
3. Comply with requirements in Section 033000 "Cast-in-Place Concrete" for cast-in-place concrete, formwork, and reinforcement.

B. Precast Concrete Handhole and Manhole Installation:

1. Comply with ASTM C891 unless otherwise indicated.
2. Install units level and plumb and with orientation and depth coordinated with connecting duct, to minimize bends and deflections required for proper entrances.
3. Unless otherwise indicated, support units on a level bed of crushed stone or gravel, graded from 1-inch sieve to No. 4 sieve and compacted to same density as adjacent undisturbed earth.

C. Elevations:

1. Manhole Roof: Install with rooftop at least 15 inches below finished grade.
2. Manhole Frame: In paved areas and trafficways, set frames flush with finished grade. Set other manhole frames 1 inch above finished grade.
3. Install handholes with bottom below frost line, below grade.

4. Handhole Covers: In paved areas and trafficways, set surface flush with finished grade. Set covers of other handholes 1 inch above finished grade.
 5. Where indicated, cast handhole cover frame integrally with handhole structure.
- D. Drainage: Install drains in bottom of manholes where indicated. Coordinate with drainage provisions indicated.
- E. Manhole Access: Circular opening in manhole roof; sized to match cover size.
1. Manholes with Fixed Ladders: Offset access opening from manhole centerlines to align with ladder.
 2. Install chimney, constructed of precast concrete collars and rings, to support cast-iron frame to connect cover with manhole roof opening. Provide moisture-tight masonry joints and waterproof grouting for frame to chimney.
- F. Waterproofing: Apply waterproofing to exterior surfaces of manholes and handholes after concrete has cured at least three days. Waterproofing materials and installation are specified in Section 071353 "Elastomeric Sheet Waterproofing." or Section 071354 "Thermoplastic Sheet Waterproofing." After duct has been connected and grouted, and before backfilling, waterproof joints and connections, and touch up abrasions and scars. Waterproof exterior of manhole chimneys after mortar has cured at least three days.
- G. Dampproofing: Apply dampproofing to exterior surfaces of manholes and handholes after concrete has cured at least three days. Dampproofing materials and installation are specified in Section 071113 "Bituminous Dampproofing." After ducts are connected and grouted, and before backfilling, dampproof joints and connections, and touch up abrasions and scars. Damp-proof exterior of manhole chimneys after mortar has cured at least three days.
- H. Hardware: Install removable hardware, including pulling eyes, cable stanchions and insulators, as required for installation and support of cables and conductors and as indicated.
- I. Fixed Manhole Ladders: Arrange to provide for safe entry with maximum clearance from cables and other items in manholes.
- J. Field-Installed Bolting Anchors in Manholes and Concrete Handholes: Do not drill deeper than 3-7/8 inches for manholes and 2 inches for handholes, for anchor bolts installed in the field. Use a minimum of two anchors for each cable stanchion.

3.7 INSTALLATION OF HANDHOLES AND BOXES OTHER THAN PRECAST CONCRETE

- A. Install handholes and boxes level and plumb and with orientation and depth coordinated with connecting duct, to minimize bends and deflections required for proper entrances. Use box extension if required to match depths of duct, and seal joint between box and extension as recommended by manufacturer.
- B. Unless otherwise indicated, support units on a level bed of crushed stone or gravel, graded from 1/2-inch sieve to No. 4 sieve and compacted to same density as adjacent undisturbed earth.
- C. Elevation: In paved areas and trafficways, set cover flush with finished grade. Set covers of other handholes 1 inch above finished grade.

- D. Install handholes and boxes with bottom below frost line, below grade.
- E. Install removable hardware, including pulling eyes, cable stanchions, cable arms, and insulators, as required for installation and support of cables and conductors and as indicated. Select arm lengths to be long enough to provide spare space for future cables, but short enough to preserve adequate working clearances in enclosure.
- F. Field cut openings for duct according to enclosure manufacturer's written instructions. Cut wall of enclosure with a tool designed for material to be cut. Size holes for terminating fittings to be used, and seal around penetrations after fittings are installed.
- G. For enclosures installed in asphalt paving and subject to occasional, nondeliberate, heavy-vehicle loading, form and pour a concrete ring encircling, and in contact with, enclosure and with top surface screeded to top of box cover frame. Bottom of ring shall rest on compacted earth.
 - 1. Concrete: 3000 psi, 28-day strength, complying with Section 033000 "Cast-in-Place Concrete," with a troweled finish.
 - 2. Dimensions: 10 inches wide by 12 inches deep

3.8 GROUNDING

- A. Ground underground ducts and utility structures according to Section 260526 "Grounding and Bonding for Electrical Systems."

3.9 FIELD QUALITY CONTROL

- A. Perform the following tests and inspections:
 - 1. Demonstrate capability and compliance with requirements on completion of installation of underground duct, duct bank, and utility structures.
 - 2. Pull solid aluminum or wood test mandrel through duct to prove joint integrity and adequate bend radii, and test for out-of-round duct. Provide a minimum 12-inch-long mandrel equal to duct size minus 1/4 inch. If obstructions are indicated, remove obstructions and retest.
 - 3. Test manhole and handhole grounding to ensure electrical continuity of grounding and bonding connections. Measure and report ground resistance as specified in Section 260526 "Grounding and Bonding for Electrical Systems."
- B. Correct deficiencies and retest as specified above to demonstrate compliance.
- C. Prepare test and inspection reports.

3.10 CLEANING

- A. Pull leather-washer-type duct cleaner, with graduated washer sizes, through full length of duct until duct cleaner indicates that duct is clear of dirt and debris. Follow with rubber duct swab for final cleaning and to assist in spreading lubricant throughout ducts.

B. Clean internal surfaces of manholes, including sump.

1. Sweep floor, removing dirt and debris.
2. Remove foreign material.

END OF SECTION

SECTION 262726 - WIRING DEVICES

PART 1 - GENERAL

1.1 RELATED DOCUMENTS

- A. Drawings and general provisions of the Contract, including General and Supplementary Conditions and Division 01 Specification Sections, apply to this Section.

1.2 SUMMARY

- A. Section Includes:
 - 1. Standard-grade receptacles, 125 V, 20 A.
 - 2. GFCI receptacles, 125 V, 20 A.
 - 3. Cord and plug sets.
 - 4. Toggle switches, 120/277 V, 20 A.
 - 5. Occupancy sensors.
 - 6. Wall plates.
 - 7. Floor service fittings.

1.3 DEFINITIONS

- A. AFCI: Arc-fault circuit interrupter.
- B. BAS: Building automation system.
- C. EMI: Electromagnetic interference.
- D. GFCI: Ground-fault circuit interrupter.
- E. Pigtail: Short lead used to connect a device to a branch-circuit conductor.
- F. RFI: Radio-frequency interference.
- G. SPD: Surge protective device.

1.4 ACTION SUBMITTALS

- A. Product Data: For each type of product.
- B. Shop Drawings: List of legends and description of materials and process used for premarking wall plates.
- C. Samples: One for each type of device and wall plate specified, in each color specified.

1.5 INFORMATIONAL SUBMITTALS

- A. Field quality-control reports.

1.6 CLOSEOUT SUBMITTALS

- A. Operation and Maintenance Data: For wiring devices to include in all manufacturers' packing-label warnings and instruction manuals that include labeling conditions.

1.7 MAINTENANCE MATERIAL SUBMITTALS

- A. Furnish extra materials that match products installed and that are packaged with protective covering for storage and identified with labels describing contents.
 - 1. Floor Service-Outlet Assemblies: One for every 10, but no fewer than one.

PART 2 - PRODUCTS

2.1 GENERAL WIRING-DEVICE REQUIREMENTS

- A. Wiring Devices, Components, and Accessories: Listed and labeled as defined in NFPA 70, by a qualified testing agency, and marked for intended location and use.
- B. Comply with NFPA 70.
- C. RoHS compliant.
- D. Comply with NEMA WD 1.
- E. Devices that are manufactured for use with modular plug-in connectors may be substituted under the following conditions:
 - 1. Connectors shall comply with UL 2459 and shall be made with stranding building wire.
 - 2. Devices shall comply with requirements in this Section.
- F. Devices for Owner-Furnished Equipment:
 - 1. Receptacles: Match plug configurations.
 - 2. Cord and Plug Sets: Match equipment requirements.
- G. Device Color:
 - 1. Wiring Devices Connected to Normal Power System: As selected by Architect unless otherwise indicated or required by NFPA 70 or device listing.
 - 2. Wiring Devices Connected to Essential Electrical System: Red.
- H. Wall Plate Color: For plastic covers, match device color.

- I. Source Limitations: Obtain each type of wiring device and associated wall plate from single source from single manufacturer.

2.2 STANDARD-GRADE RECEPTACLES, 125 V, 20 A

A. Duplex Receptacles, 125 V, 20 A:

1. Description: Two pole, three wire, and self-grounding.
2. Configuration: NEMA WD 6, Configuration 5-20R.
3. Standards: Comply with UL 498 and FS W-C-596.
4. Federal Grade.

B. Tamper-Resistant Duplex Receptacles, 125 V, 20 A:

1. Description: Two pole, three wire, and self-grounding. Integral shutters that operate only when a plug is inserted in the receptacle.
2. Configuration: NEMA WD 6, Configuration 5-20R.
3. Standards: Comply with UL 498 and FS W-C-596.
4. Marking: Listed and labeled as complying with NFPA 70, "Tamper-Resistant Receptacles" Article.
5. Federal Grade.

C. Weather-Resistant Duplex Receptacle, 125 V, 20 A:

1. Description: Two pole, three wire, and self-grounding. Integral shutters that operate only when a plug is inserted in the receptacle. Square face.
2. Configuration: NEMA WD 6, Configuration 5-20R.
3. Standards: Comply with UL 498.
4. Marking: Listed and labeled as complying with NFPA 70, "Receptacles in Damp or Wet Locations" Article.
5. Federal Grade.

D. Tamper- and Weather-Resistant Duplex Receptacles, 125 V, 20 A:

1. Description: Two pole, three wire, and self-grounding. Integral shutters that operate only when a plug is inserted in the receptacle. Square face.
2. Configuration: NEMA WD 6, Configuration 5-20R.
3. Standards: Comply with UL 498.
4. Marking: Listed and labeled as complying with NFPA 70, "Tamper-Resistant Receptacles" and "Receptacles in Damp or Wet Locations" articles.
5. Federal Grade.

2.3 GFCI RECEPTACLES, 125 V, 20 A

A. Duplex GFCI Receptacles, 125 V, 20 A:

1. Description: Integral GFCI with "Test" and "Reset" buttons and LED indicator light. Two pole, three wire, and self-grounding.
2. Configuration: NEMA WD 6, Configuration 5-20R.

- 3.Type: Feed through.
- 4.Standards: Comply with UL 498, UL 943 Class A, and FS W-C-596.
- 5.Federal Grade.

B. Tamper-Resistant Duplex GFCI Receptacles, 125 V, 20 A:

- 1.Description: Integral GFCI with "Test" and "Reset" buttons and LED indicator light. Two pole, three wire, and self-grounding. Integral shutters that operate only when a plug is inserted in the receptacle.
- 2.Configuration: NEMA WD 6, Configuration 5-20R.
- 3.Type: Feed through.
- 4.Standards: Comply with UL 498, UL 943 Class A, and FS W-C-596.
- 5.Marking: Listed and labeled as complying with NFPA 70, "Tamper-Resistant Receptacles" Article.
- 6.Federal Grade.

C. Tamper- and Weather-Resistant, GFCI Duplex Receptacles, 125 V, 20 A:

- 1.Description: Integral GFCI with "Test" and "Reset" buttons and LED indicator light. Two pole, three wire, and self-grounding. Integral shutters that operate only when a plug is inserted in the receptacle. Square face.
- 2.Configuration: NEMA WD 6, Configuration 5-15R.
- 3.Type: Feed through.
- 4.Standards: Comply with UL 498 and UL 943 Class A.
- 5.Marking: Listed and labeled as complying with NFPA 70, "Tamper-Resistant Receptacles" and "Receptacles in Damp or Wet Locations" articles.
- 6.Federal Grade.

2.4 CORD AND PLUG SETS

- A. Match voltage and current ratings and number of conductors to requirements of equipment being connected.
- B. Cord: Rubber-insulated, stranded-copper conductors, with Type SOW-A jacket; with green-insulated grounding conductor and ampacity of at least 130 percent of the equipment rating.
- C. Plug: Nylon body and integral cable-clamping jaws. Match cord and receptacle type for connection.

2.5 TOGGLE SWITCHES, 120/277 V, 20 A

- A. Single-Pole Switches, 120/277 V, 20 A:
 - 1.Standards: Comply with UL 20 and FS W-S-896.
- B. Three-Way Switches, 120/277 V, 20 A:
 - 1.Comply with UL 20 and FS W-S-896.

2.6 DIMMERS

A. Wall-Box Dimmers:

1. Description: Modular, full-wave, solid-state dimmer switch with integral, quiet on-off switches, with audible frequency and EMI/RFI suppression filters.
2. Control: Continuously adjustable slider; with single-pole or three-way switching.
3. Standards: Comply with UL 1472.
4. LED Lamp Dimmer Switches: Modular; compatible with LED lamps; trim potentiometer to adjust low-end dimming; capable of consistent dimming with low end not greater than 20 percent of full brightness.

2.7 WALL PLATES

A. Single Source: Obtain wall plates from same manufacturer of wiring devices.

B. Single and combination types shall match corresponding wiring devices.

1. Plate-Securing Screws: Metal with head color to match plate finish.
2. Material for Finished Spaces: Smooth, high-impact thermoplastic 0.035-inch-thick, satin-finished, Type 302 stainless.
3. Material for Unfinished Spaces: Galvanized steel.
4. Material for Damp Locations: Thermoplastic with spring-loaded lift cover, and listed and labeled for use in wet and damp locations.

C. Wet-Location, Weatherproof Cover Plates: NEMA 250, complying with Type 3R, weather-resistant, die-cast aluminum with lockable cover.

2.8 FLOOR BOXES

A. Manufacturers: Subject to compliance with requirements, provide products by one of the following:

1. ~~*Legrand/Wiremold RPSFB & RPSFB-OG series. Basis of Design: FSR, Inc. FL-710 with FL-710-BLP watertight cover with brass flange.~~
2. Equal products by Hubbel, Leviton, *Legrand/Wiremold may be substituted for approval.

B. Floor boxes for slab on grade:

1. Rectangular dual service metal concrete floor box with a ~~*non~~-metallic top that permits for thick concrete pours between 4" and 6" thick.
2. ~~*6 1/16" high, 5 5/16" diameter top. 8"x9"x5.25" floor box with one single gang and one double gang opening.~~
3. Graduated markings on the inside and outside of the box indicating volume capacity and depth of concrete pour.
4. Box shall accept 2HUB to allow 2" conduit feeds while maintaining 4" deep concrete pour.
5. ~~*Provide reusable concrete cap. Provide 8"x9" watertight cover with brass flange.~~
6. Conduit entry for:
 - a. 2 sides with 3/4" and 1-1/4" knockouts each side.
 - b. 2 sides with 1" knockouts each side.

- c. Bottom: two 1-1/2" knockouts.

PART 3 - EXECUTION

3.1 INSTALLATION

- A. Comply with NECA 1, including mounting heights listed in that standard, unless otherwise indicated.
- B. Coordination with Other Trades:
 1. Protect installed devices and their boxes. Do not place wall finish materials over device boxes, and do not cut holes for boxes with routers that are guided by riding against outside of boxes.
 2. Keep outlet boxes free of plaster, drywall joint compound, mortar, cement, concrete, dust, paint, and other material that may contaminate the raceway system, conductors, and cables.
 3. Install device boxes in brick or block walls so that the cover plate does not cross a joint unless the joint is troweled flush with the face of the wall.
 4. Install wiring devices after all wall preparation, including painting, is complete.
- C. Conductors:
 1. Do not strip insulation from conductors until right before they are spliced or terminated on devices.
 2. Strip insulation evenly around the conductor using tools designed for the purpose. Avoid scoring or nicking of solid wire or cutting strands from stranded wire.
 3. The length of free conductors at outlets for devices shall comply with NFPA 70, Article 300, without pigtails.
 4. Existing Conductors:
 - a. Cut back and pigtail, or replace all damaged conductors.
 - b. Straighten conductors that remain and remove corrosion and foreign matter.
 - c. Pigtailing existing conductors is permitted, provided the outlet box is large enough.
- D. Device Installation:
 1. Replace devices that have been in temporary use during construction and that were installed before building finishing operations were complete.
 2. Keep each wiring device in its package or otherwise protected until it is time to connect conductors.
 3. Do not remove surface protection, such as plastic film and smudge covers, until the last possible moment.
 4. Connect devices to branch circuits using pigtails that are not less than 6 inches in length.
 5. When there is a choice, use side wiring with binding-head screw terminals. Wrap solid conductor tightly clockwise, two-thirds to three-fourths of the way around terminal screw.
 6. Use a torque screwdriver when a torque is recommended or required by manufacturer.

7. When conductors larger than No. 12 AWG are installed on 15- or 20-A circuits, splice No. 12 AWG pigtails for device connections.
8. Tighten unused terminal screws on the device.
9. When mounting into metal boxes, remove the fiber or plastic washers used to hold device-mounting screws in yokes, allowing metal-to-metal contact.

E. Receptacle Orientation:

1. Install ground pin of vertically mounted receptacles down, and on horizontally mounted receptacles to the right.
2. Install hospital-grade receptacles in patient-care areas with the ground pin or neutral blade at the top.

F. Device Plates: Do not use oversized or extra-deep plates. Repair wall finishes and remount outlet boxes when standard device plates do not fit flush or do not cover rough wall opening.

G. Dimmers:

1. Install dimmers within terms of their listing.
2. Verify that dimmers used for fan-speed control are listed for that application.
3. Install unshared neutral conductors on line and load side of dimmers according to manufacturers' device, listing conditions in the written instructions.

H. Arrangement of Devices: Unless otherwise indicated, mount flush, with long dimension vertical and with grounding terminal of receptacles on top. Group adjacent switches under single, multigang wall plates.

I. Adjust locations of floor service outlets and service poles to suit arrangement of partitions and furnishings.

3.2 GFCI RECEPTACLES

- A. Install non-feed-through GFCI receptacles where protection of downstream receptacles is not required.

3.3 IDENTIFICATION

- A. Comply with Section 260553 "Identification for Electrical Systems."
- B. Identify each receptacle with panelboard identification and circuit number. Use hot, stamped, or engraved machine printing with white-filled lettering on face of plate, and durable wire markers or tags inside outlet boxes.
- C. Essential Electrical System: Mark receptacles supplied from the essential electrical system to allow easy identification using a self-adhesive label.

3.4 FIELD QUALITY CONTROL

- A. Test Instruments: Use instruments that comply with UL 1436.
- B. Test Instrument for Receptacles: Digital wiring analyzer with digital readout or illuminated digital-display indicators of measurement.
- C. Perform the following tests and inspections with the assistance of a factory-authorized service representative:
 - 1. In healthcare facilities, prepare reports that comply with NFPA 99.
 - 2. Test Instruments: Use instruments that comply with UL 1436.
 - 3. Test Instrument for Receptacles: Digital wiring analyzer with digital readout or illuminated digital-display indicators of measurement.
- D. Tests for Receptacles:
 - 1. Line Voltage: Acceptable range is 105 to 132 V.
 - 2. Percent Voltage Drop under 15-A Load: A value of 6 percent or higher is unacceptable.
 - 3. Ground Impedance: Values of up to 2 ohms are acceptable.
 - 4. GFCI Trip: Test for tripping values specified in UL 1436 and UL 943.
 - 5. Using the test plug, verify that the device and its outlet box are securely mounted.
 - 6. Tests shall be diagnostic, indicating damaged conductors, high resistance at the circuit breaker, poor connections, inadequate fault-current path, defective devices, or similar problems. Correct circuit conditions, remove malfunctioning units and replace with new ones, and retest as specified above.
- E. Test straight-blade for the retention force of the grounding blade according to NFPA 99. Retention force shall be not less than 4 oz.
- F. Wiring device will be considered defective if it does not pass tests and inspections.
- G. Prepare test and inspection reports.

END OF SECTION

SECTION 26 32 14 - ENGINE GENERATORS - DIESEL

PART 1 - GENERAL

1.1 SUMMARY

- A. This Section includes packaged engine-generator sets for emergency power supply with the following features:
 - 1. Diesel-engine-driven generator sets.
 - 2. Diesel engine.
 - 3. Diesel fuel-oil system.
 - 4. Control and monitoring.
 - 5. Generator overcurrent and fault protection.
 - 6. Generator, exciter, and voltage regulator.
 - 7. Outdoor engine generator enclosure.
 - 8. Remote radiator motors.
 - 9. Vibration isolation devices.

- B. Related Sections include the following:
 - 1. Division 26 Section "Transfer Switches" for transfer switches including sensors and relays to initiate automatic-starting and -stopping signals for engine-generator sets.

1.2 DEFINITIONS

- A. EPS: Emergency power supply.
- B. EPSS: Emergency power supply system.
- C. Operational Bandwidth: The total variation from the lowest to highest value of a parameter over the range of conditions indicated, expressed as a percentage of the nominal value of the parameter.

1.3 SUBMITTALS

- A. Product Data: For each type of packaged engine generator indicated. Include rated capacities, operating characteristics, and furnished specialties and accessories. In addition, include the following:
 - 1. Include rated capacities, operating characteristics, electrical characteristics, and furnished specialties and accessories.
 - 2. Include thermal damage curve for generator.
 - 3. Include time-current characteristic curves for generator protective device.
 - 4. Include fuel consumption in gallons per hour at 0.8 power factor at 0.5, 0.75, and 1.0 times generator capacity.
 - 5. Include generator efficiency at 0.8 power factor at 0.5, 0.75, and 1.0 times generator capacity.

6. Include airflow requirements for cooling and combustion air in cubic feet per minute at 0.8 power factor, with air-supply temperature of 95, 80, 70, and 50 deg F. Provide Drawings indicating requirements and limitations for location of air intake and exhausts.
 7. Include generator characteristics, including, but not limited to, kilowatt rating, efficiency, reactances, and short-circuit current capability.
- B. Shop Drawings: Detail equipment assemblies and indicate dimensions, weights, loads, required clearances, method of field assembly, components, and location and size of each field connection.
1. Include plans and elevations for engine generator and other components specified. Indicate access requirements affected by height of subbase fuel tank.
 2. Include details of equipment assemblies. Indicate dimensions, weights, loads, required clearances, method of field assembly, components, and location and size of each field connection.
 3. Identify fluid drain ports and clearance requirements for proper fluid drain.
 4. Design calculations for selecting vibration isolators and seismic restraints and for designing vibration isolation bases.
 5. Vibration Isolation Base Details: Detail fabrication including anchorages and attachments to structure and to supported equipment. Include base weights.
 6. Include diagrams for power, signal, and control wiring. Complete schematic, wiring, and interconnection diagrams showing terminal markings for engine generators and functional relationship between all electrical components.
- C. Qualification Data: For installer, manufacturer, and testing agency.
- D. Source quality-control test reports.
1. Certified summary of prototype-unit test report.
 2. Certified Test Reports: For components and accessories that are equivalent, but not identical, to those tested on prototype unit.
 3. Report of factory test on units to be shipped for this Project, showing evidence of compliance with specified requirements.
 4. Report of sound generation.
 5. Report of exhaust emissions showing compliance with applicable regulations, including EPA requirements.
 6. Certified Torsional Vibration Compatibility: Comply with NFPA 110.
- E. Field quality-control test reports.
- F. Operation and Maintenance Data: For packaged engine generators include the following:
1. List of tools and replacement items recommended to be stored at Project for ready access. Include part and drawing numbers, current unit prices, and source of supply.
- G. Warranty: Special warranty specified in this Section.

1.4 QUALITY ASSURANCE

- A. Installer Qualifications: Manufacturer's authorized representative who is trained and approved for installation of units required for this Project.

1. Maintenance Proximity: Not more than four hours' normal travel time from Installer's place of business to Project site.
- B. Manufacturer Qualifications: The engine generator supplier shall maintain 24 hour parts and service capability within 100 miles of the project site. The distributor shall stock parts as needed to support the generator set package for this specific project. The distributor shall carry sufficient inventory to cover no less than 80% of the parts service within 24 hours and 95% within 48 hours.
- C. Testing Agency Qualifications: An independent agency, with the experience and capability to conduct the testing indicated, that is a member company of the InterNational Electrical Testing Association or is a nationally recognized testing laboratory (NRTL), and that is acceptable to authorities having jurisdiction.
 1. Testing Agency's Field Supervisor: Person currently certified by the InterNational Electrical Testing Association or the National Institute for Certification in Engineering Technologies to supervise on-site testing specified in Part 3.
- D. Source Limitations: Obtain packaged generator sets and auxiliary components through one source from a single manufacturer.
- E. Electrical Components, Devices, and Accessories: Listed and labeled as defined in NFPA 70, Article 100, by a testing agency acceptable to authorities having jurisdiction, and marked for intended use.
- F. Comply with ASME B15.1.
- G. Comply with NFPA 37.
- H. Comply with NFPA 70.
- I. Comply with NFPA 110 requirements for Level 1 emergency power supply system.
- J. Comply with NFPA 111.
- K. Comply with UL 2200.
- L. Engine Exhaust Emissions: Comply with applicable state and local government requirements.
- M. Noise Emission: Comply with applicable state and local government requirements for maximum noise level at adjacent property boundaries due to sound emitted by generator set including engine, engine exhaust, engine cooling-air intake and discharge, and other components of installation.
- N. The emergency generator must be in compliance with all applicable requirements of 40 CFR Part 60 Subpart III.
 1. The engine will be provided along with manufacturer certification of compliance with pertinent emission limits.

1.5 PROJECT CONDITIONS.

- A. Environmental Conditions: Engine-generator system shall withstand the following environmental conditions without mechanical or electrical damage or degradation of performance capability:
 - 1. Ambient Temperature: 5 to 40 deg C.
 - 2. Altitude: Sea level to 1000 feet.

1.6 COORDINATION

- A. Coordinate size and location of concrete bases for package engine generators. Cast anchor-bolt inserts into bases.

1.7 WARRANTY

- A. Special Warranty: Five Year Standby Generator Set Warranty
 - 1. The manufacturer's standard warranty shall in no event be for a period of less than Five (5) years from date of initial start-up of the system and shall include repair parts, labor, reasonable travel expense necessary for repairs at the job site, and expendables (lubricating oil, filters, antifreeze, and other service items made unusable by the defect) used during the course of repair. Running hours shall be limited to 500 hours annually for the system warranty by both the manufacturer and servicing distributor. Submittals received without written warranties as specified will be rejected in their entirety.
 - 2. Warranty shall include a temporary generator set in the event a warrantable repair will take more than 48 hours. Selling dealer must have a minimum of 100 units in its rental fleet to assure a temporary unit is available if needed. Provide documentation as such.

1.8 Documentation and training

- A. Documentation: Prior to Final Acceptance, the manufacturer shall supply three (3) copies of the complete instruction manuals to Owner. The manuals shall include operation and maintenance procedures, complete parts lists, dimensional drawings, and unit wiring diagrams and schematics, and interconnection wiring diagrams.
- B. Training: Prior to Final Acceptance, the manufacturer shall provide comprehensive training to the Owner's designated personnel. Training shall cover, but not be limited to, operation, maintenance and troubleshooting of the equipment.

1.9 MAINTENANCE SERVICE

- A. Initial Maintenance Service: Beginning at Final Acceptance, provide 12 months' full maintenance by skilled employees of manufacturer's designated service organization. Include quarterly exercising to check for proper starting, load transfer, and running under load. Include routine preventive maintenance as recommended by manufacturer and adjusting as required for proper operation. Provide parts and supplies same as those used in the manufacture and installation of original equipment.

1.10 Maintenance MATERIALS

- A. Furnish extra materials described below that match products installed and that are packaged with protective covering for storage and identified with labels describing contents.
1. Fuses: One for every 10 of each type and rating, but no fewer than one of each.
 2. Indicator Lamps: Two for every six of each type used, but no fewer than two of each.
 3. Filters: One set each of lubricating oil, fuel, and combustion-air filters.

PART 2 - PRODUCTS

2.1 MANUFACTURERS

- A. Manufacturers: Subject to compliance with requirements, provide products by one of the following:
1. Caterpillar; Engine Div.
 2. Generac Power Systems, Inc.
 3. Onan/Cummins Power Generation; Industrial Business Group.

2.2 DIESEL-ENGINE-DRIVEN GENERATOR SETS

- a. Source Limitations: Obtain packaged engine generators and auxiliary components from single source from single manufacturer.

2.3 PERFORMANCE REQUIREMENTS

1. Seismic Performance: Engine generator housing, subbase fuel tank engine generator, batteries, battery racks, silencers, sound attenuating equipment, accessories, and components shall withstand the effects of earthquake motions determined according to ASCE/SEI 7.
 - 1) Component Importance Factor: 1.5.
- b. B11 Compliance: Comply with B11.19.
- c. NFPA Compliance:
 - 1) Comply with NFPA 37.
 - 2) Comply with NFPA 70.
 - 3) Comply with NFPA 110 requirements for Level 2 EPSS.
- d. UL Compliance: Comply with UL 2200.
- e. Engine Exhaust Emissions: Comply with EPA Tier 2 requirements and applicable state and local government requirements.
- f. Noise Emission: Comply with applicable state and local government requirements for maximum noise level at adjacent property boundaries due to sound emitted by engine generator including engine, engine exhaust, engine cooling-air intake and discharge, and other components of installation.
- g. Environmental Conditions: Engine generator system shall withstand the following environmental conditions without mechanical or electrical damage or degradation of performance capability:
 - 1) Ambient Temperature: 5 to 104 deg F
 - 2) Relative Humidity: Zero to 95 percent.
 - 3) Altitude: Sea level to 1000 feet.

2.4 ENGINE GENERATOR ASSEMBLY DESCRIPTION

- a. Factory-assembled and -tested, water-cooled engine, with brushless generator and accessories.
- b. Electrical Components, Devices, and Accessories: Listed and labeled as defined in NFPA 70, by a qualified testing agency, and marked for intended location and use.
- c. Power Rating: Standby.
- d. EPSS Class: Engine generator shall be classified as a Class 2 according to NFPA 110.
- e. Service Load: 218 kVA.
- f. Power Factor: 0.8, lagging.
- g. Frequency: 60 Hz.
- h. Voltage: 208-V ac.
- i. Phase: Three-phase, four wire, wye.
- j. Induction Method: Naturally aspirated.
- k. Governor: Adjustable isochronous, with speed sensing.
- l. Mounting Frame: Structural steel framework to maintain alignment of mounted components without depending on concrete foundation. Provide lifting attachments sized and spaced to prevent deflection of base during lifting and moving.
 - 1) Rigging Diagram: Inscribed on metal plate permanently attached to mounting frame to indicate location and lifting capacity of each lifting attachment and engine generator center of gravity.
- m. Capacities and Characteristics:
 - 1) Power Output Ratings: Nominal ratings as indicated at 0.8 power factor excluding power required for the continued and repeated operation of the unit and auxiliaries.
 - 2) Nameplates: For each major system component to identify manufacturer's name and address, and model and serial number of component.
- n. Engine Generator Performance:
 - 1) Steady-State Voltage Operational Bandwidth: 3 percent of rated output voltage from no load to full load.
 - 2) Transient Voltage Performance: Not more than 20 percent variation for 50 percent step-load increase or decrease. Voltage shall recover and remain within the steady-state operating band within three seconds.
 - 3) Steady-State Frequency Operational Bandwidth: 0.5 percent of rated frequency from no load to full load.
 - 4) Steady-State Frequency Stability: When system is operating at any constant load within the rated load, there shall be no random speed variations outside the steady-state operational band and no hunting or surging of speed.
 - 5) Transient Frequency Performance: Less than 5 percent variation for 50 percent step-load increase or decrease. Frequency shall recover and remain within the steady-state operating band within five seconds.
 - 6) Output Waveform: At no load, harmonic content measured line to line or line to neutral shall not exceed 5 percent total and 3 percent for single harmonics. Telephone influence factor, determined according to NEMA MG 1, shall not exceed 50 percent.
 - 7) Sustained Short-Circuit Current: For a three-phase, bolted short circuit at system output terminals, system shall supply a minimum of 250 percent of rated full-load current for not less than 10 seconds and then clear the fault automatically, without damage to generator system components.
 - 8) Start Time:

- a) Comply with NFPA 110, Type 10 system requirements.

2.5 DIESEL ENGINE

- a. Fuel: ASTM D975, diesel fuel oil, Grade 2-D S15.
- b. Rated Engine Speed: 1800 rpm.
- c. Lubrication System: Engine or skid-mounted.
 - 1) Filter and Strainer: Rated to remove 90 percent of particles 5 micrometers and smaller while passing full flow.
 - 2) Thermostatic Control Valve: Control flow in system to maintain optimum oil temperature. Unit shall be capable of full flow and is designed to be fail-safe.
 - 3) Crankcase Drain: Arranged for complete gravity drainage to an easily removable container with no disassembly and without use of pumps, siphons, special tools, or appliances.
- d. Jacket Coolant Heater: Electric-immersion type, factory installed in coolant jacket system. Comply with UL 499 and with NFPA 110 requirements for Level 1 equipment for heater capacity.
- e. Integral Cooling System: Closed loop, liquid cooled, with radiator factory mounted on engine generator set mounting frame and integral engine-driven coolant pump.
 - 1) Coolant: Solution of 50 percent ethylene-glycol-based antifreeze and 50 percent water, with anticorrosion additives as recommended by engine manufacturer.
 - 2) Size of Radiator: Adequate to contain expansion of total system coolant from cold start to 110 percent load condition.
 - 3) Expansion Tank: Constructed of welded steel plate and rated to withstand maximum closed-loop coolant system pressure for engine used. Equip with gage glass and petcock.
 - 4) Temperature Control: Self-contained, thermostatic-control valve modulates coolant flow automatically to maintain optimum constant coolant temperature as recommended by engine manufacturer.
 - 5) Coolant Hose: Flexible assembly with inside surface of nonporous rubber and outer covering of aging-, UV-, and abrasion-resistant fabric.
 - a) Rating: 50-psig maximum working pressure with coolant at 180 deg F, and noncollapsible under vacuum.
 - b) End Fittings: Flanges or steel pipe nipples with clamps to suit piping and equipment connections.
- f. Muffler/Silencer:
 - 1) Commercial type, sized as recommended by engine manufacturer and selected with exhaust piping system to not exceed engine manufacturer's engine backpressure requirements.
 - a) Minimum sound attenuation of 12 dB at 500 Hz.
 - b) Sound level measured at a distance of 25 feet from exhaust discharge after installation is complete shall be 90 dBA or less.
- g. Air-Intake Filter: Standard-duty, engine-mounted air cleaner with replaceable dry-filter element and "blocked filter" indicator.
- h. Starting System: 12-V electric, with negative ground.
 - 1) Components: Sized so they are not damaged during a full engine-cranking cycle with ambient temperature at maximum specified in "Performance Requirements" Article.

- 2) Cranking Motor: Heavy-duty unit that automatically engages and releases from engine flywheel without binding.
- 3) Cranking Cycle: As required by NFPA 110 for system level specified.
- 4) Battery: Lead acid, with capacity within ambient temperature range specified in "Performance Requirements" Article to provide specified cranking cycle at least twice without recharging.
- 5) Battery Cable: Size as recommended by engine manufacturer for cable length indicated. Include required interconnecting conductors and connection accessories.
- 6) Battery Compartment: Factory fabricated of metal with acid-resistant finish and thermal insulation. Thermostatically controlled heater shall be arranged to maintain battery above 50 deg F regardless of external ambient temperature within range specified in "Performance Requirements" Article. Include accessories required to support and fasten batteries in place. Provide ventilation to exhaust battery gases.
- 7) Battery Stand: Factory-fabricated, two-tier metal with acid-resistant finish designed to hold the quantity of battery cells required and to maintain the arrangement to minimize lengths of battery interconnections.
- 8) Battery-Charging Alternator: Factory mounted on engine with solid-state voltage regulation and 35-A minimum continuous rating.
- 9) Battery Charger: Current-limiting, automatic-equalizing, and float-charging type designed for lead-acid batteries. Unit shall comply with UL 1236 and include the following features:
 - a) Operation: Equalizing-charging rate of 10 A shall be initiated automatically after battery has lost charge until an adjustable equalizing voltage is achieved at battery terminals. Unit shall then be automatically switched to a lower float-charging mode and shall continue to operate in that mode until battery is discharged again.
 - b) Automatic Temperature Compensation: Adjust float and equalize voltages for variations in ambient temperature from minus 40 to 140 deg F to prevent overcharging at high temperatures and undercharging at low temperatures.
 - c) Automatic Voltage Regulation: Maintain constant output voltage regardless of input voltage variations up to plus or minus 10 percent.
 - d) Ammeter and Voltmeter: Flush mounted in door. Meters shall indicate charging rates.
 - e) Safety Functions: Sense abnormally low battery voltage and close contacts providing low battery voltage indication on control and monitoring panel. Sense high battery voltage and loss of ac input or dc output of battery charger. Either condition shall close contacts that provide a battery-charger malfunction indication at system control and monitoring panel.
 - f) Enclosure and Mounting: NEMA 250, Type 1, wall-mounted cabinet.

2.6 DIESEL FUEL-OIL SYSTEM

- a. Comply with NFPA 37.
- b. Piping: Fuel-oil piping shall be Schedule 40 black steel, complying with requirements in Section 231113 "Facility Fuel-Oil Piping." Cast iron, aluminum, copper, and galvanized steel shall not be used in the fuel-oil system.

- c. Main Fuel Pump: Mounted on engine to provide primary fuel flow under starting and load conditions.
- d. Fuel Filtering: Remove water and contaminants larger than 1 micron.
- e. Relief-Bypass Valve: Automatically regulates pressure in fuel line and returns excess fuel to source.
- f. Subbase-Mounted, Double-Wall, Fuel-Oil Tank: Factory installed and piped, complying with UL 142 fuel-oil tank. Features include the following:
 - 1) Tank level indicator.
 - 2) Fuel-Tank Capacity: Minimum ~~133 percent of total fuel required for planned operation plus fuel for periodic maintenance operations between fuel refills.~~ **of 72-hour operation at 80% full rated generator output.**
 - 3) Leak detection in interstitial space.
 - 4) Vandal-resistant fill cap.
 - 5) Containment Provisions: Comply with requirements of authorities having jurisdiction.

2.7 CONTROL AND MONITORING

- a. Automatic Starting System Sequence of Operation: When mode-selector switch on the control and monitoring panel is in the automatic position, remote-control contacts in one or more separate automatic transfer switches initiate starting and stopping of engine generator. When mode-selector switch is switched to the on position, engine generator starts. The off position of same switch initiates engine generator shutdown. When engine generator is running, specified system or equipment failures or derangements automatically shut down engine generator and initiate alarms.
- b. Provide minimum run time control set for 30 minutes with override only by operation of a remote emergency-stop switch.
- c. Comply with UL 508A.
- d. Configuration:
 - 1) Operating and safety indications, protective devices, basic system controls, and engine gages shall be grouped in a common control and monitoring panel mounted on the engine generator. Mounting method shall isolate the control panel from engine generator vibration. Panel shall be powered from the engine generator battery.
 - a) Wall-Mounting Cabinet Construction: Rigid, self-supporting steel unit complying with NEMA ICS 6.
- e. Control and Monitoring Panel:
 - 1) Digital engine generator controller with integrated LCD display, controls, and microprocessor, capable of local and remote control, monitoring, and programming, with battery backup.
 - 2) Instruments: Located on the control and monitoring panel and viewable during operation.
 - a) Engine lubricating-oil pressure gage.
 - b) Engine-coolant temperature gage.
 - c) DC voltmeter (alternator battery charging).
 - d) Running-time meter.
 - e) AC voltmeter, [for each phase] [connected to a phase selector switch].
 - f) AC ammeter, [for each phase] [connected to a phase selector switch].
 - g) AC frequency meter.

- h) Generator-voltage adjusting rheostat.
- 3) Controls and Protective Devices: Controls, shutdown devices, and common alarm indication, including the following:
 - a) Cranking control equipment.
 - b) Run-Off-Auto switch.
 - c) Control switch not in automatic position alarm.
 - d) Overcrank alarm.
 - e) Overcrank shutdown device.
 - f) Low-water temperature alarm.
 - g) High engine temperature prealarm.
 - h) High engine temperature.
 - i) High engine temperature shutdown device.
 - j) Overspeed alarm.
 - k) Overspeed shutdown device.
 - l) Low fuel main tank.
 - i. Low-fuel-level alarm shall be initiated when the level falls below that required for operation for duration required for the indicated EPSS class.
 - m) Coolant low-level alarm.
 - n) EPS load indicator.
 - o) Battery high-voltage alarm.
 - p) Low cranking voltage alarm.
 - q) Battery-charger malfunction alarm.
 - r) Battery low-voltage alarm.
 - s) Lamp test.
 - t) Contacts for local and remote common alarm.
 - u) Low-starting air pressure alarm.
 - v) Low-starting hydraulic pressure alarm.
 - w) Remote manual stop shutdown device.
 - x) Air shutdown damper alarm when used.
 - y) Air shutdown damper shutdown device when used.
 - z) Generator overcurrent-protective-device not-closed alarm.
 - aa) Hours of operation.
 - bb) Engine generator metering, including voltage, current, hertz, kilowatt, kilovolt ampere, and power factor.
- f. Engine Generator Metering: Comply with [Section 260913 "Electrical Power Monitoring and Control."] [Section 262713 "Electricity Metering."] [Section 260913 "Electrical Power Monitoring and Control" and Section 262713 "Electricity Metering."]
- g. Remote Alarm Annunciator: An LED indicator light labeled with proper alarm conditions shall identify each alarm event, and a common audible signal shall sound for each alarm condition. Silencing switch in face of panel shall silence signal without altering visual indication. Connect so that after an alarm is silenced, clearing of initiating condition will reactivate alarm until silencing switch is reset. Cabinet and faceplate are surface- or flush-mounting type to suit mounting conditions indicated.
 - 1) Overcrank alarm.
 - 2) Low water-temperature alarm.
 - 3) High engine temperature prealarm.
 - 4) High engine temperature alarm.
 - 5) Low lube oil pressure alarm.

- 6) Overspeed alarm.
 - 7) Low fuel main tank alarm.
 - 8) Low coolant level alarm.
 - 9) Low cranking voltage alarm.
 - 10) Contacts for local and remote common alarm.
 - 11) Audible-alarm silencing switch.
 - 12) Air shutdown damper when used.
 - 13) Run-Off-Auto switch.
 - 14) Control switch not in automatic position alarm.
 - 15) Low-cranking voltage alarm.
- h. Supporting Items: Include sensors, transducers, terminals, relays, and other devices and include wiring required to support specified items. Locate sensors and other supporting items on engine or generator unless otherwise indicated.
- i. Remote Emergency-Stop Switch: Flush; wall mounted unless otherwise indicated; and labeled. Push button shall be protected from accidental operation.

2.8 GENERATOR OVERCURRENT AND FAULT PROTECTION

- a. Overcurrent protective devices shall be coordinated to optimize selective tripping when a short circuit occurs.
- 1) Overcurrent protective devices for the entire EPSS shall be coordinated to optimize selective tripping when a short circuit occurs. Coordination of protective devices shall consider both utility and EPSS as the voltage source.
 - 2) Overcurrent protective devices for the EPSS shall be accessible only to authorized personnel.
- b. Generator Overcurrent Protective Device:
- 1) Insulated-case circuit breaker, electronic-trip type; 100 percent rated; complying with UL 489:
 - a) Tripping Characteristics: Adjustable long-time and short-time delay and instantaneous.
 - b) Trip Settings: Selected to coordinate with generator thermal damage curve.
 - c) Shunt Trip: Connected to trip breaker when engine generator is shut down by other protective devices.
 - d) Mounting: Adjacent to, or integrated with, control and monitoring panel.
- c. Generator Protector: Microprocessor-based unit shall continuously monitor current level in each phase of generator output, integrate generator heating effect over time, and predict when thermal damage of alternator will occur. When signaled by generator protector or other engine generator protective devices, a shunt-trip device in the generator disconnect switch shall open the switch to disconnect the generator from load circuits. Protector performs the following functions:
- 1) Initiates a generator overload alarm when generator has operated at an overload equivalent to 110 percent of full-rated load for 60 seconds. Indication for this alarm is integrated with other engine generator malfunction alarms. Contacts shall be available for load shed functions.
 - 2) Under single- or three-phase fault conditions, regulates generator to 300 percent of rated full-load current for up to 10 seconds.
 - 3) As overcurrent heating effect on the generator approaches the thermal damage point of the unit, protector switches the excitation system off, opens the generator disconnect device, and shuts down the engine generator.

- 4)Senses clearing of a fault by other overcurrent devices and controls recovery of rated voltage to avoid overshoot.

2.9 GENERATOR, EXCITER, AND VOLTAGE REGULATOR

- a. Comply with NEMA MG 1.
- b. Drive: Generator shaft shall be directly connected to engine shaft. Exciter shall be rotated integrally with generator rotor.
- c. Electrical Insulation: Class H.
- d. Stator-Winding Leads: Brought out to terminal box to permit future reconnection for other voltages if required. Provide 12-lead alternator.
- e. Range: Provide **extended** range of output voltage by adjusting the excitation level.
- f. Construction shall prevent mechanical, electrical, and thermal damage due to vibration, overspeed up to 125 percent of rating, and heat during operation at 110 percent of rated capacity.
- g. Enclosure: Dripproof.
- h. Instrument Transformers: Mounted within generator enclosure.
- i. Voltage Regulator: Solid-state type, separate from exciter, providing performance as specified and as required by NFPA 11.
 - 1)Adjusting Rheostat on Control and Monitoring Panel: Provide plus or minus 5 percent adjustment of output-voltage operating band.
 - 2)Maintain voltage within 15 percent on one step, full load.
 - 3)Provide anti-hunt provision to stabilize voltage.
 - 4)Maintain frequency within 5 percent and stabilize at rated frequency within 5 seconds.
- j. Strip Heater: Thermostatically controlled unit arranged to maintain stator windings above dew point.
- k. Windings: Two-thirds pitch stator winding and fully linked amortisseur winding.
- l. Subtransient Reactance: 12 percent, maximum.

2.10 OUTDOOR ENGINE GENERATOR ENCLOSURE

- a. Description:
 - 1)Vandal-resistant, sound-attenuating, weatherproof steel housing; wind resistant up to 100 mph. Multiple panels shall be lockable and provide adequate access to components requiring maintenance. Panels shall be removable by one person without tools. Instruments and control shall be mounted within enclosure.
 - a) Sound Attenuation Level: 1
- b. Structural Design and Anchorage: Comply with ASCE/SEI 7 for wind loads up to 100 mph.
- c. Space Heater: Thermostatically controlled and sized to prevent condensation.
- d. Lighting: Provide weather-resistant LED lighting with 30 fc average maintained.
- e. Thermal Insulation: Manufacturer's standard materials and thickness selected in coordination with space heater to maintain winter interior temperature within operating limits required by engine generator components.
- f. Muffler Location: Within enclosure.

- g. Engine-Cooling Airflow through Enclosure: Maintain temperature rise of system components within required limits when unit operates at 110 percent of rated load for two hours with ambient temperature at top of range specified in system service conditions.

2.11 VIBRATION ISOLATION DEVICES

- a. Elastomeric Isolator Pads: Oil- and water-resistant elastomer or natural rubber, arranged in single or multiple layers, molded with a nonslip pattern and galvanized-steel baseplates of sufficient stiffness for uniform loading over pad area, and factory cut to sizes that match requirements of supported equipment.
- b. Restrained Spring Isolators: Freestanding, steel, open-spring isolators with seismic restraint.
 - 1) Housing: Steel with resilient vertical-limit stops to prevent spring extension due to wind loads or if weight is removed; factory-drilled baseplate bonded to 1/4-inch- thick, elastomeric isolator pad attached to baseplate underside; and adjustable equipment-mounting and -leveling bolt that acts as blocking during installation.
 - 2) Outside Spring Diameter: Not less than 80 percent of compressed height of the spring at rated load.
 - 3) Minimum Additional Travel: 50 percent of required deflection at rated load.
 - 4) Lateral Stiffness: More than 80 percent of rated vertical stiffness.
 - 5) Overload Capacity: Support 200 percent of rated load, fully compressed, without deformation or failure.
 - 6) Minimum Deflection: 1 inch.

2.12 FINISHES

- a. Indoor and Outdoor Enclosures and Components: Manufacturer's standard finish over corrosion-resistant pretreatment and compatible primer.

2.13 SOURCE QUALITY CONTROL

- a. Prototype Testing: Factory test engine generator using same engine model, constructed of identical or equivalent components and equipped with identical or equivalent accessories.
 - 1) Tests: Comply with IEEE 115[and with NFPA 110, Level 1 Energy Converters].
- b. Project-Specific Equipment Tests: Before shipment, factory test engine generator and other system components and accessories manufactured specifically for this Project. Perform tests at rated load and power factor. Include the following tests:
 - 1) Test components and accessories furnished with installed unit that are not identical to those on tested prototype to demonstrate compatibility and reliability.
 - 2) Test generator, exciter, and voltage regulator as a unit.
 - 3) Full load run.
 - 4) Maximum power.
 - 5) Voltage regulation.
 - 6) Transient and steady-state governing.
 - 7) Single-step load pickup.
 - 8) Safety shutdown.

9) Report factory test results within 10 days of completion of test.

PART 3 - EXECUTION

3.1 EXAMINATION

- a. Examine areas, equipment bases, and conditions, with Installer present, for compliance with requirements for installation and other conditions affecting packaged engine generator performance.
- b. Examine roughing-in for piping systems and electrical connections. Verify actual locations of connections before packaged engine generator installation.
- c. Proceed with installation only after unsatisfactory conditions have been corrected.

3.2 INSTALLATION

- a. Comply with NECA 1 and NECA 404.
- b. Comply with packaged engine generator manufacturers' written installation and alignment instructions and with NFPA 110.
- c. Equipment Mounting:
 - 1) Install packaged engine generators on cast-in-place concrete equipment bases. Comply with requirements for equipment bases and foundations specified in Section 033000 "Cast-in-Place Concrete."
 - 2) Coordinate size and location of concrete bases for packaged engine generators. Cast anchor-bolt inserts into bases. Concrete, reinforcement, and formwork requirements are specified with concrete.
 - 3) Install packaged engine generator with elastomeric isolator pads having a minimum deflection of 1 inch on 4-inch- high concrete base. Secure enclosure to anchor bolts installed in concrete bases.
- d. Install packaged engine generator to provide access, without removing connections or accessories, for periodic maintenance.
- e. Install electrical devices furnished by equipment manufacturers but not specified to be factory mounted.

3.3 IDENTIFICATION

- a. Identify system components according to Section 230553 "Identification for HVAC Piping and Equipment" and Section 260553 "Identification for Electrical Systems."

3.4 FIELD QUALITY CONTROL

- a. Testing Agency:
 - 1) Engage a factory-authorized service representative to test and inspect components, assemblies, and equipment installations, including connections.
- b. Tests and Inspections:
 - 1) Perform tests recommended by manufacturer and each visual and mechanical inspection and electrical and mechanical test listed in first two subparagraphs below, as specified in NETA ATS. Certify compliance with test parameters.
 - a) Visual and Mechanical Inspection:

- ii. Compare equipment nameplate data with Drawings and the Specifications.
- iii. Inspect physical and mechanical condition.
- iv. Inspect anchorage, alignment, and grounding.
- v. Verify that the unit is clean.
- b) Electrical and Mechanical Tests:
 - vi. Perform insulation-resistance tests according to IEEE 43. Machines 200 hp or Less: Test duration shall be one minute. Calculate the dielectric-absorption ratio.
 - vii. Test protective relay devices.
 - viii. Verify phase rotation, phasing, and synchronized operation as required by the application.
 - ix. Functionally test engine shutdown for low oil pressure, overtemperature, overspeed, and other protection features as applicable.
 - x. Verify correct functioning of the governor and regulator.
- 2) NFPA 110 Acceptance Tests: Perform tests required by NFPA 110 that are additional to those specified here, including, but not limited to, single-step full-load pickup test.
- 3) Battery Tests: Equalize charging of battery cells according to manufacturer's written instructions. Record individual cell voltages.
 - a) Measure charging voltage and voltages between available battery terminals for full-charging and float-charging conditions. Check electrolyte level and specific gravity under both conditions.
 - b) Test for contact integrity of all connectors. Perform an integrity load test and a capacity load test for the battery.
 - c) Verify acceptance of charge for each element of the battery after discharge.
 - d) Verify that measurements are within manufacturer's specifications.
- 4) Battery-Charger Tests: Verify specified rates of charge for both equalizing and float-charging conditions.
- 5) System Integrity Tests: Methodically verify proper installation, connection, and integrity of each element of engine generator system before and during system operation. Check for air, exhaust, and fluid leaks.
- 6) Voltage and Frequency Transient Stability Tests: Use recording oscilloscope to measure voltage and frequency transients for 50 and 100 percent step-load increases and decreases, and verify that performance is as specified.
- 7) Harmonic-Content Tests: Measure harmonic content of output voltage at 25 and 100 percent of rated linear load. Verify that harmonic content is within specified limits.
- 8) Noise Level Tests: Measure A-weighted level of noise emanating from engine generator installation, including engine exhaust and cooling-air intake and discharge, at four locations 25 feet from edge of the generator enclosure and compare measured levels with required values.
- c. Coordinate tests with tests for transfer switches and run them concurrently.
- d. Test instruments shall have been calibrated within the past 12 months, traceable to NIST Calibration Services, and adequate for making positive observation of test results. Make calibration records available for examination on request.
- e. Leak Test: After installation, charge exhaust, coolant, and fuel systems and test for leaks. Repair leaks and retest until no leaks exist.
- f. Operational Test: After electrical circuitry has been energized, start units to confirm proper motor rotation and unit operation for generator and associated equipment.

- g. Test and adjust controls and safeties. Replace damaged and malfunctioning controls and equipment.
- h. Remove and replace malfunctioning units and retest as specified above.
- i. Retest: Correct deficiencies identified by tests and observations, and retest until specified requirements are met.
- j. Report results of tests and inspections in writing. Record adjustable relay settings and measured insulation resistances, time delays, and other values and observations. Attach a label or tag to each tested component indicating satisfactory completion of tests.
- k. Infrared Scanning: After Substantial Completion, but not more than 60 days after final acceptance, perform an infrared scan of each power wiring termination and each bus connection while running with maximum load. Remove all access panels so terminations and connections are accessible to portable scanner.
 - 1) Follow-up Infrared Scanning: Perform an additional follow-up infrared scan 11 months after date of Substantial Completion.
 - 2) Instrument: Use an infrared scanning device designed to measure temperature or to detect significant deviations from normal values. Provide calibration record for device.
 - 3) Record of Infrared Scanning: Prepare a certified report that identifies terminations and connections checked and that describes scanning results. Include notation of deficiencies detected, remedial action taken, and observations after remedial action.

3.5 MAINTENANCE SERVICE

- a. Initial Maintenance Service: Beginning at Substantial Completion, maintenance service shall include 12 months' full maintenance by skilled employees of manufacturer's authorized service representative. Include quarterly preventive maintenance and exercising to check for proper starting, load transfer, and running under load. Include routine preventive maintenance as recommended by manufacturer and adjusting as required for proper operation. Parts shall be manufacturer's authorized replacement parts and supplies.

3.6 DEMONSTRATION

- a. Engage a factory-authorized service representative to train Owner's maintenance personnel to adjust, operate, and maintain packaged engine generators.

END OF SECTION 26 32 14

SECTION 284621.11 - ADDRESSABLE FIRE-ALARM SYSTEMS

PART 1 - GENERAL

1.1 RELATED DOCUMENTS

- A. Drawings and general provisions of the Contract, including General and Supplementary Conditions and Division 01 Specification Sections, apply to this Section.

1.2 SUMMARY

A. Section Includes:

1. Addressable fire-alarm system.
2. Fire-alarm control unit (FACU).
3. Manual fire-alarm boxes.
4. System smoke detectors.
5. Heat detectors.
6. Fire-alarm notification appliances.
7. Firefighters' two-way telephone communication service.
8. Fire-alarm graphic annunciators.
9. Fire-alarm remote annunciators.
10. Fire-alarm addressable interface devices.
11. Fire-alarm radio transmitters.

B. Related Requirements:

1. Section 087100 "Door Hardware" for magnetic door holders that release in response to fire-alarm outputs.
2. Section 260519 "Low-Voltage Electrical Power Conductors and Cables" for cables and conductors for fire-alarm systems.

1.3 DEFINITIONS

- A. DACT: Digital alarm communicator transmitter.
- B. EMT: Electrical metallic tubing.
- C. FACU: Fire-alarm control unit.
- D. Mode: The terms "Active Mode," "Off Mode," and "Standby Mode" are used as defined in the 2007 Energy Independence and Security Act (EISA).
- E. NICET: National Institute for Certification in Engineering Technologies.
- F. PC: Personal computer.

- G. Voltage Class: For specified circuits and equipment, voltage classes are defined as follows:
1. Control Voltage: Listed and labeled for use in remote-control, signaling, and power-limited circuits supplied by a Class 2 or Class 3 power supply having rated output not greater than 150 V and 5 A, allowing use of alternate wiring methods complying with NFPA 70, Article 725.
 2. Low Voltage: Listed and labeled for use in circuits supplied by a Class 1 or other power supply having rated output not greater than 1000 V, requiring use of wiring methods complying with NFPA 70, Article 300, Part I.

1.4 ACTION SUBMITTALS

- A. Approved Permit Submittal: Submittals must be approved by authorities having jurisdiction prior to submitting them to Architect.
- B. Product Data: For each type of product, including furnished options and accessories.
1. Include construction details, material descriptions, dimensions, profiles, and finishes.
 2. Include rated capacities, operating characteristics, and electrical characteristics.
- C. Shop Drawings: For fire-alarm system.
1. Comply with recommendations and requirements in "Documentation" section of "Fundamentals" chapter in NFPA 72.
 2. Include plans, elevations, sections, and details, including details of attachments to other Work.
 3. Include details of equipment assemblies. Indicate dimensions, weights, loads, required clearances, method of field assembly, components, and locations. Indicate conductor sizes, indicate termination locations and requirements, and distinguish between factory and field wiring.
 4. Graphic Annunciator panel details as required by authorities having jurisdiction.
 5. Detail assembly and support requirements.
 6. Include voltage drop calculations for notification-appliance circuits.
 7. Include battery-size calculations.
 8. Include input/output matrix.
 9. Include written statement from manufacturer that equipment and components have been tested as a system and comply with requirements in this Section and in NFPA 72.
 10. Include performance parameters and installation details for each detector.
 11. Verify that each duct detector is listed for complete range of air velocity, temperature, and humidity possible when air-handling system is operating.
 12. Provide program report showing that air-sampling detector pipe layout balances pneumatically within airflow range of air-sampling detector.
 13. Provide control wiring diagrams for fire-alarm interface to HVAC; coordinate location of duct smoke detectors and access to them.
 - a. Show critical dimensions that relate to placement and support of sampling tubes, detector housing, and remote status and alarm indicators.
 - b. Show field wiring and equipment required for HVAC unit shutdown on alarm.
 - c. Locate detectors in accordance with manufacturer's written instructions.
 - d. Show air-sampling detector pipe routing.

14. Include voice/alarm signaling-service equipment rack or console layout, grounding

- D. Delegated Design Submittal: For notification appliances and smoke and heat detectors, in addition to submittals listed above, indicate compliance with performance requirements and design criteria, including analysis data signed and sealed by qualified professional engineer responsible for their preparation.
1. Drawings showing location of each notification appliance and smoke and heat detector, ratings of each, and installation details as needed to comply with listing conditions of device.
 2. Design Calculations: Calculate requirements for selecting spacing and sensitivity of detection, complying with NFPA 72. Calculate spacing and intensities for strobe signals and sound-pressure levels for audible appliances.
 3. Indicate audible appliances required to produce square wave signal per NFPA 72.

1.5 INFORMATIONAL SUBMITTALS

A. Certificates:

1. Seismic Performance Certificates: For FACU, accessories, and components, from manufacturer. Include the following information:
 - a. Basis for Certification: Indicate whether withstand certification is based on actual test of assembled components or on calculation.
 - b. Dimensioned Outline Drawings of Equipment Unit: Identify center of gravity and locate and describe mounting and anchorage provisions.
 - c. Detailed description of equipment anchorage devices on which certification is based and their installation requirements.

B. Field quality-control reports.

C. Qualification Statements: For Installer.

D. Sample Warranty: Submittal must include line item pricing for replacement parts and labor.

1.6 CLOSEOUT SUBMITTALS

A. Operation and Maintenance Data: For fire-alarm systems and components to include in emergency, operation, and maintenance manuals.

1. In addition to items specified in Section 017823 "Operation and Maintenance Data," include the following and deliver copies to authorities having jurisdiction:
 - a. Comply with "Records" section of "Inspection, Testing and Maintenance" chapter in NFPA 72.
 - b. Provide "Fire-Alarm and Emergency Communications System Record of Completion Documents" in accordance with "Completion Documents" Article in "Documentation" section of "Fundamentals" chapter in NFPA 72.

- c. Complete wiring diagrams showing connections between devices and equipment. Each conductor must be numbered at every junction point with indication of origination and termination points.
- d. Riser diagram.
- e. Device addresses.
- f. Air-sampling system sample port locations and modeling program report showing layout meets performance criteria.
- g. Record copy of site-specific software.
- h. Provide "Inspection and Testing Form" in accordance with "Inspection, Testing and Maintenance" chapter in NFPA 72, and include the following:
 - 1) Equipment tested.
 - 2) Frequency of testing of installed components.
 - 3) Frequency of inspection of installed components.
 - 4) Requirements and recommendations related to results of maintenance.
 - 5) Manufacturer's user training manuals.
- i. Manufacturer's required maintenance related to system warranty requirements.
- j. Abbreviated operating instructions for mounting at FACU and each annunciator unit.

B. Software and Firmware Operational Documentation:

1. Software operating and upgrade manuals.
2. Program Software Backup: On USB media.
3. Device address list.
4. Printout of software application and graphic screens.

1.7 MAINTENANCE MATERIAL SUBMITTALS

- A. Extra Stock Material: Furnish extra materials that match products installed and that are packaged with protective covering for storage and identified with labels describing contents.
1. Lamps for Remote Indicating Lamp Units: Quantity equal to 10 percent of amount installed, but no fewer than one unit.
 2. Lamps for Strobe Units: Quantity equal to 10 percent of amount installed, but no fewer than one unit.
 3. Smoke Detectors, Fire Detectors: Quantity equal to 10 percent of amount of each type installed, but no fewer than one unit of each type.
 4. Detector Bases: Quantity equal to two percent of amount of each type installed, but no fewer than one unit of each type.
 5. Keys and Tools: One extra set for access to locked or tamper proof components.
 6. Audible and Visual Notification Appliances: One of each type installed.
 7. Fuses: Two of each type installed in system. Provide in box or cabinet with compartments marked with fuse types and sizes.
 8. Filters for Air-Sampling Detectors: Quantity equal to two percent of amount of each type installed, but no fewer than one unit of each type.
 9. Air-Sampling Fan: Quantity equal to one for every five detectors, but no fewer than one unit of each type.

1.8 QUALITY ASSURANCE

A. Installer Qualifications:

1. Personnel must be trained and certified by the manufacturer for installation of units required for this Project.
2. Installation must be by personnel certified by NICET as fire-alarm Level III technician.
3. Obtain certification by NRTL in accordance with NFPA 72.
4. Licensed or certified by authorities having jurisdiction.

1.9 FIELD CONDITIONS

A. Seismic Conditions: Unless otherwise indicated on Contract Documents, specified Work in this Section must withstand the seismic hazard design loads determined in accordance with ASCE/SEI 7.

1. The term "withstand" means "unit must remain in place without separation of parts from unit when subjected to specified seismic design loads and unit must be fully operational after seismic event."

1.10 WARRANTY

A. Special Warranty: Manufacturer agrees to repair or replace fire-alarm system equipment and components that fail because of defects in materials or workmanship within specified warranty period.

1. Warranty Period: Five years from date of Substantial Completion.

PART 2 - PRODUCTS

2.1 ADDRESSABLE FIRE-ALARM SYSTEM

A. Description:

1. Noncoded, UL-certified addressable system, with multiplexed signal transmission and horn-and-strobe notification for evacuation.

B. Performance Criteria:

1. Regulatory Requirements:

- a. Fire-Alarm Components, Devices, and Accessories: Listed and labeled by a NRTL in accordance with NFPA 70 for use with selected fire-alarm system and marked for intended location and application.

2. General Characteristics:

- a. Automatic sensitivity control of certain smoke detectors.

- b. Fire-alarm signal initiation must be by one or more of the following devices and systems:
- 1) Manual stations.
 - 2) Heat detectors.
 - 3) Smoke detectors.
 - 4) Fire-extinguishing system operation.
- c. Fire-alarm signal must initiate the following actions:
- 1) Continuously operate alarm notification appliances.
 - 2) Identify alarm and specific initiating device at FACU, connected network control panels, off-premises network control panels, and remote annunciators.
 - 3) Transmit alarm signal to remote alarm receiving station.
 - 4) Unlock electric door locks in designated egress paths.
 - 5) Release fire and smoke doors held open by magnetic door holders.
 - 6) Activate voice/alarm communication system.
 - 7) Switch HVAC equipment controls to fire-alarm mode.
 - 8) Activate emergency lighting control.
 - 9) Activate emergency shutoffs for gas and fuel supplies, except for shutoffs serving legally required life-safety systems such as emergency generators.
 - 10) Record events in system memory.
 - 11) Record events by system printer.
 - 12) Indicate device in alarm on graphic annunciator.
- d. Supervisory signal initiation must be by one or more of the following devices and actions:
- 1) Zones or individual devices have been disabled.
 - 2) FACU has lost communication with network.
- e. System trouble signal initiation must be by one or more of the following devices and actions:
- 1) Open circuits, shorts, and grounds in designated circuits.
 - 2) Opening, tampering with, or removing alarm-initiating and supervisory signal-initiating devices.
 - 3) Loss of communication with addressable sensor, input module, relay, control module, remote annunciator, printer interface, or Ethernet module.
 - 4) Loss of primary power at FACU.
 - 5) Ground or single break in internal circuits of FACU.
 - 6) Abnormal ac voltage at FACU.
 - 7) Break in standby battery circuitry.
 - 8) Failure of battery charging.
 - 9) Abnormal position of switch at FACU or annunciator.
 - 10) Voice signal amplifier failure.
 - 11) Hose cabinet door open.

- f. System Supervisory Signal Actions:
- 1) Initiate notification appliances.
 - 2) Identify specific device initiating event at FACU, connected network control panels, off-premises network control panels, and remote annunciators.
 - 3) Record event on system printer.
 - 4) After time delay of 200 seconds, transmit trouble or supervisory signal to remote alarm receiving station.
 - 5) Transmit system status to building management system.
 - 6) Display system status on graphic annunciator.
- g. Network Communications:
- 1) Provide network communications for fire-alarm system in accordance with fire-alarm manufacturer's written instructions.
 - 2) Provide network communications pathway per manufacturer's written instructions and requirements in NFPA 72 and NFPA 70.
 - 3) Provide integration gateway using Modbus for connection to building automation system.
- h. System Printer:
- 1) Printer must be listed and labeled as integral part of fire-alarm system.
- i. Device Guards:
- 1) Description: Welded wire mesh of size and shape for manual station, smoke detector, gong, or other device requiring protection.
 - a) Factory fabricated and furnished by device manufacturer.
 - b) Finish: Paint of color to match protected device.
- j. Document Storage Box:
- 1) Description: Enclosure to accommodate standard 8-1/2-by-11 inch manuals and loose document records. Legend sheet will be permanently attached to door for system required documentation, key contacts, and system information. Provide two key ring holders with location to mount standard business cards for key contact personnel.
 - 2) Material and Finish: 18-gauge cold-rolled steel; four mounting holes.
 - 3) Color: Red powder-coat epoxy finish.
 - 4) Labeling: Permanently screened with 1 inch high lettering "SYSTEM RECORD DOCUMENTS" with white indelible ink.
 - 5) Security: Locked with 3/4 inch barrel lock. Provide solid 12 inch stainless steel piano hinge.

2.2 FIRE-ALARM CONTROL UNIT (FACU)

- A. Manufacturers: Subject to compliance with requirements, available manufacturers offering products that may be incorporated into the Work include, but are not limited to the following:

1. Gamewell-FCI; Honeywell International, Inc.
 2. Notifier; Honeywell International, Inc.
 3. Simplex; brand of Johnson Controls International plc, Building Solutions North America.
- B. Description: Field-programmable, microprocessor-based, modular, power-limited design with electronic modules.
- C. Performance Criteria:
1. Regulatory Requirements: Comply with NFPA 72 and UL 864.
 2. General Characteristics:
 - a. System software and programs must be held in nonvolatile flash, electrically erasable, programmable, read-only memory, retaining information through failure of primary and secondary power supplies.
 - b. Include real-time clock for time annotation of events on event recorder and printer.
 - c. Provide communication between FACU and remote circuit interface panels, annunciators, and displays.
 - d. FACU must be listed for connection to central-station signaling system service.
 - e. Provide nonvolatile memory for system database, logic, and operating system and event history. System must require no manual input to initialize in the event of complete power down condition. FACU must provide minimum 500-event history log.
 - f. Addressable Initiation Device Circuits: FACU must indicate which communication zones have been silenced and must provide selective silencing of alarm notification appliance by building communication zone.
 - 1) Addressable Control Circuits for Operation of Notification Appliances and Mechanical Equipment: FACU must be listed for releasing service.
 - g. Fire-Alarm Annunciator: Arranged for interface between human operator at FACU and addressable system components including annunciation and supervision. Display alarm, supervisory, and component status messages and programming and control menu.
 - 1) Annunciator and Display: LCD, 80 characters, minimum.
 - 2) Keypad: Arranged to permit entry and execution of programming, display, and control commands.
 - h. Alphanumeric Display and System Controls: Arranged for interface between human operator at FACU and addressable system components including annunciation and supervision. Display alarm, supervisory, and component status messages and programming and control menu.
 - 1) Annunciator and Display: LCD, two line(s) of 80 characters, minimum.
 - 2) Keypad: Arranged to permit entry and execution of programming, display, and control commands and to indicate control commands to be entered into system for control of smoke-detector sensitivity and other parameters.
 - i. Initiating-Device, Notification-Appliance, and Signaling-Line Circuits:

- 1) Pathway Class Designations: NFPA 72, Class A (Signaling-Line) and Class B (Initiating, Notification-Appliances).
 - 2) Pathway Survivability: Level 1.
 - 3) Install no more than 50 addressable devices on each signaling-line circuit.
 - 4) Install fault circuit isolators to comply with circuit performance requirements of NFPA 72 or with manufacturer's written instructions, whichever is more conservative.
- j. Serial Interfaces:
- 1) One dedicated RS 485 port for central-station operation using point ID DACT.
 - 2) One RS 485 port for remote annunciators, Ethernet module, or multi-interface module (printer port).
 - 3) One USB port for PC configuration.
 - 4) One RS 232 port for air-aspirating smoke detector connection.
 - 5) One RS 232 port for voice evacuation interface.
- k. Notification-Appliance Circuit:
- 1) Audible appliances must sound in three-pulse temporal pattern, as defined in NFPA 72.
 - 2) Where notification appliances provide signals to sleeping areas, alarm signal must be 520 Hz square wave with intensity 15 dB above average ambient sound level or 5 dB above maximum sound level, or at least 75 dB(A-weighted), whichever is greater, measured at pillow.
 - 3) Visual alarm appliances must flash in synchronization where multiple appliances are in same field of view, as defined in NFPA 72.
- l. Door Controls: Door hold-open devices that are controlled by smoke detectors at doors in smoke-barrier walls must [not]be connected to fire-alarm system.
- m. Voice/Alarm Signaling Service: Central emergency communication system with redundant microphones, preamplifiers, amplifiers, and tone generators provided as special module that is part of FACU.
- n. Indicate number of alarm channels for automatic, simultaneous transmission of different announcements to different zones or for manual transmission of

announcements by use of central-control microphone. Amplifiers must comply with UL 1711.

- 1) Allow application of, and evacuation signal to, indicated number of zones and simultaneously allow voice paging to other zones selectively or in combination.
 - 2) Programmable tone and message sequence selection.
 - 3) Standard digitally recorded messages for "Evacuation" and "All Clear."
 - 4) Generate tones to be sequenced with audio messages of type recommended by NFPA 72 and that are compatible with tone patterns of notification-appliance circuits of FACU.
- o. Status Annunciator: Indicate status of various voice/alarm speaker zones and status of firefighters' two-way telephone communication zones.
 - p. Preamplifiers, amplifiers, and tone generators must automatically transfer to backup units, on primary equipment failure.
 - q. Printout of Events: On receipt of signal, print alarm, supervisory, and trouble events. Identify zone, device, and function. Include type of signal (alarm, supervisory, or trouble) and date and time of occurrence. Differentiate alarm signals from other printed indications. Also, print system reset event, including same information for device, location, date, and time. Commands initiate printing of list of existing alarm, supervisory, and trouble conditions in system and historical log of events.
 - r. Primary Power: 24 V(dc) obtained from 120 V(ac) service and power-supply module. Initiating devices, notification appliances, signaling lines, trouble signals, and supervisory signals must be powered by 24 V(dc) source.
 - s. Alarm current draw of entire fire-alarm system must not exceed 80 percent of power-supply module rating.
 - t. Secondary Power: 24 V(dc) supply system with batteries, automatic battery charger, and automatic transfer switch.
 - 1) 60 hours of battery power capacity, plus 15 minutes of full alarm load.
 - u. Batteries: Sealed lead calcium.

D. Accessories:

1. Instructions: Computer printout or typewritten instruction card mounted behind plastic or glass cover in stainless steel or aluminum frame. Include interpretation and describe appropriate response for displays and signals. Briefly describe functional operation of system under normal, alarm, and trouble conditions.

2.3 MANUAL FIRE-ALARM BOXES

- A. General Requirements for Manual Fire-Alarm Boxes: Comply with UL 38. Boxes must be finished in red with molded, raised-letter operating instructions in contrasting color; must show

visible indication of operation; and must be mounted on recessed outlet box. If indicated as surface mounted, provide manufacturer's surface back box.

1. Double-action mechanism requiring two actions to initiate alarm, pull-lever type; with integral addressable module arranged to communicate manual-station status (normal, alarm, or trouble) to FACU.
2. Station Reset: Key- or wrench-operated switch.
3. Weatherproof Protective Shield: Factory-fabricated, clear plastic enclosure hinged at top to permit lifting for access to initiate alarm.
4. Able to perform at up to 90 percent relative humidity at 90 deg F.

2.4 SYSTEM SMOKE DETECTORS

A. Photoelectric Smoke Detectors:

1. Performance Criteria:
 - a. Regulatory Requirements:
 - 1) NFPA 72.
 - b. General Characteristics:
 - 1) Detectors must be four-wire type.
 - 2) Base Mounting: Detector and associated electronic components must be mounted in twist-lock module that connects to fixed base. Provide terminals in fixed base for connection to building wiring.
 - 3) Self-Restoring: Detectors do not require resetting or readjustment after actuation to restore them to normal operation.
 - 4) Integral Visual-Indicating Light: LED type, indicating detector has operated and power-on status.
 - 5) Detector address must be accessible from FACU and must be able to identify detector's location within system and its sensitivity setting.
 - 6) Operator at FACU, having designated access level, must be able to manually access the following for each detector:
 - a) Primary status.
 - b) Device type.
 - c) Present average value.
 - d) Present sensitivity selected.
 - e) Sensor range (normal, dirty, etc.).
 - 7) Detector must have functional humidity range within 10 to 90 percent relative humidity.
 - 8) Color: White.

2.5 HEAT DETECTORS

A. Fixed-Temperature-Type Heat Detectors:

1. Performance Criteria:

a. Regulatory Requirements:

- 1) NFPA 72.
- 2) UL 521.

b. General Characteristics:

- 1) Actuated by temperature that exceeds fixed temperature of 190 deg F.
- 2) Mounting: Twist-lock base interchangeable with smoke-detector bases.
- 3) Integral Addressable Module: Arranged to communicate detector status (normal, alarm, or trouble) to FACU.
- 4) Detector must have functional humidity range of 10 to 90 percent.
- 5) Color: White.

2. DUCT SMOKE DETECTORS

a. Description: Photoelectric-type, duct-mounted smoke detector.

b. Performance Criteria:

1) Regulatory Requirements:

- a) NFPA 72.
- b) UL 268A.

2) General Characteristics:

- a) Detectors must be four-wire type.
- b) Integral Addressable Module: Arranged to communicate detector status (normal, alarm, or trouble) to FACU.
- c) Self-Restoring: Detectors do not require resetting or readjustment after actuation to restore them to normal operation.
- d) Integral Visual-Indicating Light: LED type, indicating detector has operated.
- e) Detector address must be accessible from FACU and must be able to identify detector's location within system and its sensitivity setting.
- f) Operator at FACU, having designated access level, must be able to manually access the following for each detector:
 1. Primary status.
 2. Device type.
 3. Present average value.
 4. Present sensitivity selected.
 5. Sensor range (normal, dirty, etc.).
- g) Weatherproof Duct Housing Enclosure: NEMA 250, Type 4X; NRTL listed for use with supplied detector for smoke detection in HVAC system ducts.
- h) Each sensor must have multiple levels of detection sensitivity.

- i) Sampling Tubes: Design and dimensions as recommended by manufacturer for specific duct size, air velocity, and installation conditions where applied.
- j) Relay Fan Shutdown: Fully programmable relay rated to interrupt fan motor-control circuit.

2.6 FIRE-ALARM NOTIFICATION APPLIANCES

1. Description: Horns, bells, or other notification devices that cannot output voice messages.
2. Performance Criteria:
 - a. Regulatory Requirements:
 - 1) NFPA 72.
 - b. General Characteristics:
 - 1) Individually addressed, connected to signaling-line circuit, equipped for mounting as indicated, and with screw terminals for system connections.
 - 2) Connected to notification-appliance signal circuits, zoned as indicated, equipped for mounting as indicated, and with screw terminals for system connections.
 - 3) Chimes, Low-Level Output: Vibrating type, 85 dB(A-weighted) minimum rated output.
 - 4) Chimes, High-Level Output: Vibrating type, 85 dB(A-weighted) minimum rated output.
 - 5) Sounders, High Volume 24 V(dc): Less than 6 mA of alarm current.
 - 6) Sounders, Low Volume 24 V(dc): Less than 4 mA of alarm current.
 - 7) Audible notification appliances must have functional humidity range of 10 to 95 percent relative humidity.
 - 8) ISO Temporal 3 Evacuation Tone: 90 plus or minus 4 dB(A-weighted) at 24 V.
 - 9) ISO Temporal 3 Alert Tone: 95 plus or minus 5 dB(A-weighted) at 24 V.
 - 10) AS2220 Evacuation Tone: 93 plus or minus 4 dB(A-weighted) at 24 V.
 - 11) AS2220 Alert Tone: 93 plus or minus 5 dB(A-weighted) at 24 V.
 - 12) Horns: Electric-vibrating-polarized type, 24 V(dc); with provision for housing operating mechanism behind grille. Comply with UL 464. Horns must produce sound-pressure level of 90 dB(A-weighted), measured 10 ft. from horn, using coded signal prescribed in UL 464 test protocol.

B. Fire-Alarm Visible Notification Appliances:

1. Performance Criteria:
 - a. Regulatory Requirements:
 - 1) NFPA 72.
 - 2) UL 1971.
 - b. General Characteristics:
 - 1) Rated Light Output:
 - a) 15/30/75/110 cd, selectable in field.
 - 2) Clear or nominal white polycarbonate lens mounted on aluminum faceplate.
 - 3) Mounting: Wall mounted unless otherwise indicated.
 - 4) For units with guards to prevent physical damage, light output ratings must be determined with guards in place.
 - 5) Flashing must be in temporal pattern, synchronized with other units.
 - 6) Strobe Leads: Factory connected to screw terminals.
 - 7) Mounting Faceplate: Factory finished, red.

2.7 FIREFIGHTERS' TWO-WAY TELEPHONE COMMUNICATION SERVICE

- A. Description: Dedicated, two-way, supervised, telephone voice communication links between FACU and remote firefighters' telephone stations. Supervised telephone lines must be connected to talk circuits by controls in control module.
- B. Performance Criteria:
 1. Regulatory Requirements:
 - a. NFPA 72.
 2. General Characteristics:
 - a. Common-talk type for firefighter use only.
 - b. Controls to disconnect phones from talk circuits if too many phones are in use simultaneously. Indicator lamp must flash if phone is disconnected from talk circuits.
 - c. Addressable firefighters' phone modules to monitor and control loop of firefighter phones. Module must be capable of differentiating between normal, off-hook, and trouble conditions.
 - d. Audible Pulse and Tone Generator, and High-Intensity Lamp: When remote telephone is taken off hook, it causes audible signal to sound and high-intensity lamp to flash at FACU.
 - e. Selector panel controls to provide for simultaneous operation of up to six telephones in selected zones. Indicate ground faults and open or shorted telephone lines on panel front by individual LEDs.
 - f. Display: Graphic to indicate location of caller.
 - g. Remote Telephone Cabinet: Flush- or surface-mounted cabinet as indicated; factory-standard red finish; with handset.

- 1) Install one-piece handset to cabinet with vandal-resistant armored cord. Silk-screened or engraved label on cabinet door, designating "Fire Emergency Phone."
 - 2) With "break-glass" door access lock.
- h. Remote Telephone Jack Stations: Single-gang, stainless steel-plate mounted plug, engraved "Fire Emergency Phone."
- i. Handsets: push-to-talk stored in cabinet adjacent to FACU.

2.8 FIRE-ALARM GRAPHIC ANNUNCIATORS

A. Performance Criteria:

1. Regulatory Requirements:

- a. NFPA 72.

2. General Characteristics:

- a. Graphic Annunciator Panel: Mounted in aluminum frame with nonglare, minimum 3/16 inch thick, clear acrylic cover over graphic representation of facility. Detector locations must be represented by red LED lamps. Normal system operation must be indicated by lighted, green LED. Trouble and supervisory alarms must be represented by amber LED.
 - 1) Comply with UL 864.
 - 2) Operating voltage must be 24 V(dc) provided by local 24 V power supply provided with annunciator.
 - 3) Include built-in voltage regulation, reverse polarity protection, RS 232/422 serial communications, and lamp test switch.
 - 4) Surface mounted in NEMA 250, Type 1 cabinet, with key lock and no exposed screws or hinges.
 - 5) Graphic representation of facility must be CAD drawing and each detector must be represented by LED in its actual location. CAD drawing must be at 1:96 scale or larger.
 - 6) LED representing detector must flash two times per second while detector is in alarm.

2.9 FIRE-ALARM REMOTE ANNUNCIATORS

A. Performance Criteria:

1. Regulatory Requirements:

- a. NFPA 72.

2. General Characteristics:

- a. Annunciator functions must match those of FACU for alarm, supervisory, and trouble indications. Manual switching functions must match those of FACU, including acknowledging, silencing, resetting, and testing.
 - 1) Mounting: Flush cabinet, NEMA 250, Type 1.
- b. Display Type and Functional Performance: Alphanumeric display and LED indicating lights must match those of FACU. Provide controls to acknowledge, silence, reset, and test functions for alarm, supervisory, and trouble signals.

2.10 FIRE-ALARM ADDRESSABLE INTERFACE DEVICES

A. Performance Criteria:

1. Regulatory Requirements:
 - a. NFPA 72.
2. General Characteristics:
 - a. Include address-setting means on module.
 - b. Store internal identifying code for control panel use to identify module type.
 - c. Listed for controlling HVAC fan motor controllers.
 - d. Monitor Module: Microelectronic module providing system address for alarm-initiating devices for wired applications with normally open contacts.

2.11 FIRE-ALARM RADIO TRANSMITTERS

A. Performance Criteria:

1. Regulatory Requirements:
 - a. NFPA 72.
 - b. NFPA 1221.
 - c. 47 CFR 90.
2. General Characteristics:
 - a. Must be factory assembled, wired, and tested; ready for installation and operation.
 - b. Packaging: Single, modular, NEMA 250, Type 1 metal enclosure with tamper-resistant flush tumbler lock.
 - c. Signal Transmission Mode and Frequency: VHF or UHF 2-W power output, coordinated with operating characteristics of established remote alarm receiving station designated by Owner.
 - d. Normal Power Input: 120 V(ac).
 - e. Secondary Power: Integral-sealed, rechargeable, 12 V battery and charger. Comply with NFPA 72 requirements for battery capacity; submit calculations.
 - 1) Antenna: Omnidirectional, coaxial half-wave, dipole type with driving point impedance matched to transmitter and antenna cable output impedance.

- Wind-load strength of antenna and mounting hardware and supports must withstand 100 mph with gust factor of 1.3 without failure.
 - 2) Antenna Cable: Coaxial cable with impedance matched to transmitter output impedance.
 - 3) Antenna-Cable Connectors: Weatherproof.
 - 4) Alarm Interface Devices: Circuit boards, modules, and other auxiliary devices, integral to transmitter, matching fire-alarm and other system outputs to message-generating inputs of transmitter that produce required message transmissions.

- f. Functional Performance: Unit must receive alarm, supervisory, or trouble signal from FACU or from its own internal sensors or controls and must automatically transmit signal along with unique code that identifies transmitting station to remote alarm receiving station. Transmitted messages must correspond to standard designations for fire-reporting system to which signal is being transmitted and must include separately designated messages in response to the following events or conditions:
 - 1) Transmitter Low-Battery Condition: Sent when battery voltage is below 85 percent of rated value.
 - 2) System Test Message: Initiated manually by test switch within transmitter cabinet, or automatically at optionally preselected time, once every 24 hours, with transmission time controlled by programmed timing device integral to transmitter controls.
 - 3) Transmitter Trouble Message: Actuated by failure, in excess of one-minute duration, of transmitter normal power source, derangement of wiring of transmitter, or alarm input interface circuit or device connected to it.
 - 4) Local Fire-Alarm-System Trouble Message: Initiated by events or conditions that cause trouble signal to be indicated on building system.
 - 5) Local Fire-Alarm-System Alarm Message: Actuated when building system goes into alarm state. Identifies device that initiated alarm.
 - 6) Local Fire-Alarm-System, Supervisory-Alarm Message: Actuated when building alarm system indicates supervisory alarm.

2.12 DIGITAL ALARM COMMUNICATOR TRANSMITTERS (DACTs)

A. Manufacturer:

- 1. Preferred Brand Alternate: Digital Security Controls #DSC300TLF

B. Performance Criteria:

1. Regulatory Requirements:

- a. NFPA 72.

2. General Characteristics:

- a. DACT must be acceptable to remote central station and must be listed for fire-alarm use.

3. Functional Performance: Unit must receive alarm, supervisory, or trouble signal from FACU and automatically capture two data cables and dial preset number for remote central

station. When contact is made with central station(s), signals must be transmitted. If service on either line is interrupted for longer than 45 seconds, transmitter must initiate local trouble signal and transmit signal indicating loss of telephone line to remote alarm receiving station over remaining line. Transmitter must automatically report telephone service restoration to central station. If service is lost on both telephone lines, transmitter must initiate local trouble signal.

a. Local functions and display at DACT must include the following:

- 1) Verification that both telephone lines are available.
- 2) Programming device.
- 3) LED display.
- 4) Manual test report function and manual transmission clear indication.
- 5) Communications failure with central station or FACU.
- 6) Digital data transmission must include the following:
 - a) Address of alarm-initiating device.
 - b) Address of supervisory signal.
 - c) Address of trouble-initiating device.
 - d) Loss of ac supply.
 - e) Loss of power.
 - f) Low battery.
 - g) Abnormal test signal.
 - h) Communication bus failure.
 - i) Secondary Power: Integral rechargeable battery and automatic charger.
 - j) Self-Test: Conducted automatically every 24 hours with report transmitted to central station.

PART 3 - EXECUTION

3.1 EXAMINATION

- A. Examine areas and conditions for compliance with requirements for ventilation, temperature, humidity, and other conditions affecting performance of the Work.
 1. Verify that manufacturer's written instructions for environmental conditions have been permanently established in spaces where equipment and wiring are installed, before installation begins.
- B. Examine roughing-in for electrical connections to verify actual locations of connections before installation.
- C. Proceed with installation only after unsatisfactory conditions have been corrected.

3.2 ~~PREPARATION~~

- ~~A. Preinstallation Testing: Perform verification of functionality of installed components of existing system prior to starting work. Document equipment or components not functioning as designed.~~
- ~~B. Protection of In-Place Conditions: Protect devices during construction unless devices are placed in service to protect facility during construction.~~

3.3 INSTALLATION OF EQUIPMENT

- A. Comply with NECA 305, NFPA 72, NFPA 101, and requirements of authorities having jurisdiction for installation and testing of fire-alarm equipment. Install electrical wiring to comply with requirements in NFPA 70 including, but not limited to, Article 760, "Fire Alarm Systems."
1. Devices placed in service before other trades have completed cleanup must be replaced.
 2. Devices installed, but not yet placed, in service must be protected from construction dust, debris, dirt, moisture, and damage in accordance with manufacturer's written storage instructions.
- ~~B. Connecting to Existing Equipment: Verify that existing fire alarm system is operational before making changes or connections.~~
- ~~1. Connect new equipment to existing control panel in existing part of building.~~
 - ~~2. Connect new equipment to existing monitoring equipment at supervising station.~~
 - ~~3. Expand, modify, and supplement existing [control] [monitoring] equipment as necessary to extend existing [control] [monitoring] functions to new points. New components must be capable of merging with existing configuration without degrading performance of either system.~~
 - ~~4. Install seismic bracing. Comply with requirements in Section 270548.16 "Seismic Controls for Communications Systems."~~
 - ~~5. Install dowel rods to connect concrete base to concrete floor. Unless otherwise indicated, install dowel rods on 18 inch centers around full perimeter of concrete base.~~
 - ~~6. For supported equipment, install epoxy-coated anchor bolts that extend through concrete base and anchor into structural concrete floor.~~
 - ~~7. Place and secure anchorage devices. Use setting drawings, templates, diagrams, instructions, and directions furnished with items to be embedded.~~
 - ~~8. Install anchor bolts to elevations required for proper attachment to supported equipment.~~
- C. Install wall-mounted equipment, with tops of cabinets not more than 78 inch above finished floor.
1. Comply with requirements for seismic-restraint devices specified in Section 270548.16 "Seismic Controls for Communications Systems."
- D. Manual Fire-Alarm Boxes:
1. Install manual fire-alarm box in normal path of egress within 60 inch of exit doorway.

2. Mount manual fire-alarm box on background of contrasting color.

3. Operable part of manual fire-alarm box must be between 42 and 48 inch above floor level. Devices must be mounted at same height unless otherwise indicated.
 4. Smooth ceiling spacing must not exceed 30 ft..
 5. Spacing of detectors for irregular areas, for irregular ceiling construction, and for high ceiling areas must be determined in accordance with Annex A in NFPA 72.
 6. HVAC: Locate detectors not closer than 36 inch from air-supply diffuser or return-air opening.
 7. Lighting Fixtures: Locate detectors not closer than 12 inch from lighting fixture and not directly above pendant mounted or indirect lighting.
- E. Install cover on each smoke detector that is not placed in service during construction. Cover must remain in place except during system testing. Remove cover prior to system turnover.
- F. Single-Station Smoke Detectors: Where more than one smoke alarm is installed within dwelling or suite, they must be connected so that operation of smoke alarm causes alarm in smoke alarms to sound.
- G. Remote Status and Alarm Indicators: Install in visible location near each smoke detector, sprinkler water-flow switch, and valve-tamper switch that is not readily visible from normal viewing position.
- H. Audible Alarm-Indicating Devices: Install not less than 6 inch below ceiling. Install bells and horns on flush-mounted back boxes with device-operating mechanism concealed behind grille. Install devices at same height unless otherwise indicated.
- I. Visible Alarm-Indicating Devices: Install adjacent to each alarm bell or alarm horn and at least 6 inch below ceiling. Install devices at same height unless otherwise indicated.
- J. Device Location-Indicating Lights: Locate in public space near device they monitor.
- K. Antenna for Radio Alarm Transmitter: Mount to building structure where indicated. Use mounting arrangement and substrate connection that resists wind load of 100 mph with gust factor of 1.3 without damage.

3.4 ELECTRICAL CONNECTIONS

- A. Connect wiring in accordance with Section 260519 "Low-Voltage Electrical Power Conductors and Cables."
- B. Ground equipment in accordance with Section 260526 "Grounding and Bonding for Electrical Systems."
- C. Install electrical devices furnished by manufacturer, but not factory mounted, in accordance with NFPA 70 and NECA 1.
- D. Install nameplate for each electrical connection, indicating electrical equipment designation and circuit number feeding connection.
 1. Nameplate must be laminated acrylic or melamine plastic signs, as specified in Section 260553 "Identification for Electrical Systems."

2. Nameplate must be laminated acrylic or melamine plastic signs with black background and engraved white letters at least 1/2 inch high.

3.5 CONTROL CONNECTIONS

- A. Install control and electrical power wiring to field-mounted control devices.
- B. Connect control wiring in accordance with Section 260523 "Control-Voltage Electrical Power Cables."
- C. Install nameplate for each control connection, indicating field control panel designation and I/O control designation feeding connection.

3.6 PATHWAYS

- A. Pathways above recessed ceilings and in inaccessible locations may be routed exposed.
 1. Exposed pathways located less than 96 inch above floor must be installed in EMT.
- B. Pathways must be installed in EMT.
- C. Exposed EMT must be painted red enamel.

3.7 CONNECTIONS

- A. For fire-protection systems related to doors in fire-rated walls and partitions and to doors in smoke partitions, comply with requirements in Section 087100 "Door Hardware." Connect hardware and devices to fire-alarm system.
 1. Verify that hardware and devices are listed for use with installed fire-alarm system before making connections.
- B. Make addressable connections with supervised interface device to the following devices and systems. Install interface device less than 36 inch from device controlled. Make addressable confirmation connection when such feedback is available at device or system being controlled.
 1. Smoke dampers in air ducts of designated HVAC duct systems.
 2. Electronically locked doors and access gates.
 3. Alarm-initiating connection to activate emergency lighting control.
 4. Data communication circuits for connection to building management system.
 5. Supervisory connections at fire-extinguisher locations.

3.8 IDENTIFICATION

- A. Identify system components, wiring, cabling, and terminals. Comply with requirements for identification specified in Section 270553 "Identification for Communications Systems."
- B. Install framed instructions in location visible from FACU.

3.9 GROUNDING

- A. Ground FACU and associated circuits in accordance with Section 260526 "Grounding and Bonding for Electrical Systems."
- B. Ground shielded cables at control panel location only. Insulate shield at device location.

3.10 FIELD QUALITY CONTROL

- A. Field tests must be witnessed by authorities having jurisdiction.
- B. Administrant for Tests and Inspections:
 - 1. Engage factory-authorized service representative to administer and perform tests and inspections on components, assemblies, and equipment installations, including connections.
- C. Tests and Inspections:
 - 1. Visual Inspection: Conduct visual inspection prior to testing.
 - a. Inspection must be based on completed record Drawings and system documentation that is required by "Completion Documents, Preparation" table in "Documentation" section of "Fundamentals" chapter in NFPA 72.
 - b. Comply with "Visual Inspection Frequencies" table in "Inspection" section of "Inspection, Testing and Maintenance" chapter in NFPA 72; retain "Initial/Reacceptance" column and list only installed components.
 - 2. System Testing: Comply with "Test Methods" table in "Testing" section of "Inspection, Testing and Maintenance" chapter in NFPA 72.
 - 3. Test audible appliances for public operating mode in accordance with manufacturer's written instructions. Perform test using portable sound-level meter complying with Type 2 requirements in ASA S1.4 Part 1/IEC 61672-1.
 - 4. Test audible appliances for private operating mode in accordance with manufacturer's written instructions.
 - 5. Test visible appliances for public operating mode in accordance with manufacturer's written instructions.
 - 6. Factory-authorized service representative must prepare "Fire Alarm System Record of Completion" in "Documentation" section of "Fundamentals" chapter in NFPA 72 and "Inspection and Testing Form" in "Records" section of "Inspection, Testing and Maintenance" chapter in NFPA 72.
- D. Reacceptance Testing: Perform reacceptance testing to verify proper operation of added or replaced devices and appliances.
- E. Fire-alarm system will be considered defective if it does not pass tests and inspections.
- F. Prepare test and inspection reports.

- G. Maintenance Test and Inspection: Perform tests and inspections listed for weekly, monthly, quarterly, and semiannual periods. Use forms developed for initial tests and inspections.
- H. Annual Test and Inspection: One year after date of Substantial Completion, test fire-alarm system complying with visual and testing inspection requirements in NFPA 72. Use forms developed for initial tests and inspections.

3.11 DEMONSTRATION

- A. Engage a factory-authorized service representative to train Owner's maintenance personnel to adjust, operate, and maintain fire-alarm system.

3.12 MAINTENANCE

- A. Maintenance Service: Beginning at Substantial Completion, maintenance service must include 12 months' full maintenance by skilled employees of manufacturer's designated service organization. Include preventive maintenance, repair or replacement of worn or defective components, lubrication, cleaning, and adjusting as required for proper operation. Parts and supplies must be manufacturer's authorized replacement parts and supplies.
 - 1. Include visual inspections in accordance with "Visual Inspection Frequencies" table in "Testing" paragraph of "Inspection, Testing and Maintenance" chapter in NFPA 72.
 - 2. Perform tests in "Test Methods" table in "Testing" paragraph of "Inspection, Testing and Maintenance" chapter in NFPA 72.
 - 3. Perform tests per "Testing Frequencies" table in "Testing" paragraph of "Inspection, Testing and Maintenance" chapter in NFPA 72.

3.13 SOFTWARE SERVICE AGREEMENT

- A. Comply with UL 864.
- B. Technical Support: Beginning at Substantial Completion, service agreement must include software support for two years.
- C. Upgrade Service: At Substantial Completion, update software to latest version. Install and program software upgrades that become available within two years from date of Substantial Completion. Upgrading software must include operating system and new or revised licenses for using software.
 - 1. Upgrade Notice: At least 30 days to allow Owner to schedule access to system and to upgrade computer equipment if necessary.

END OF SECTION

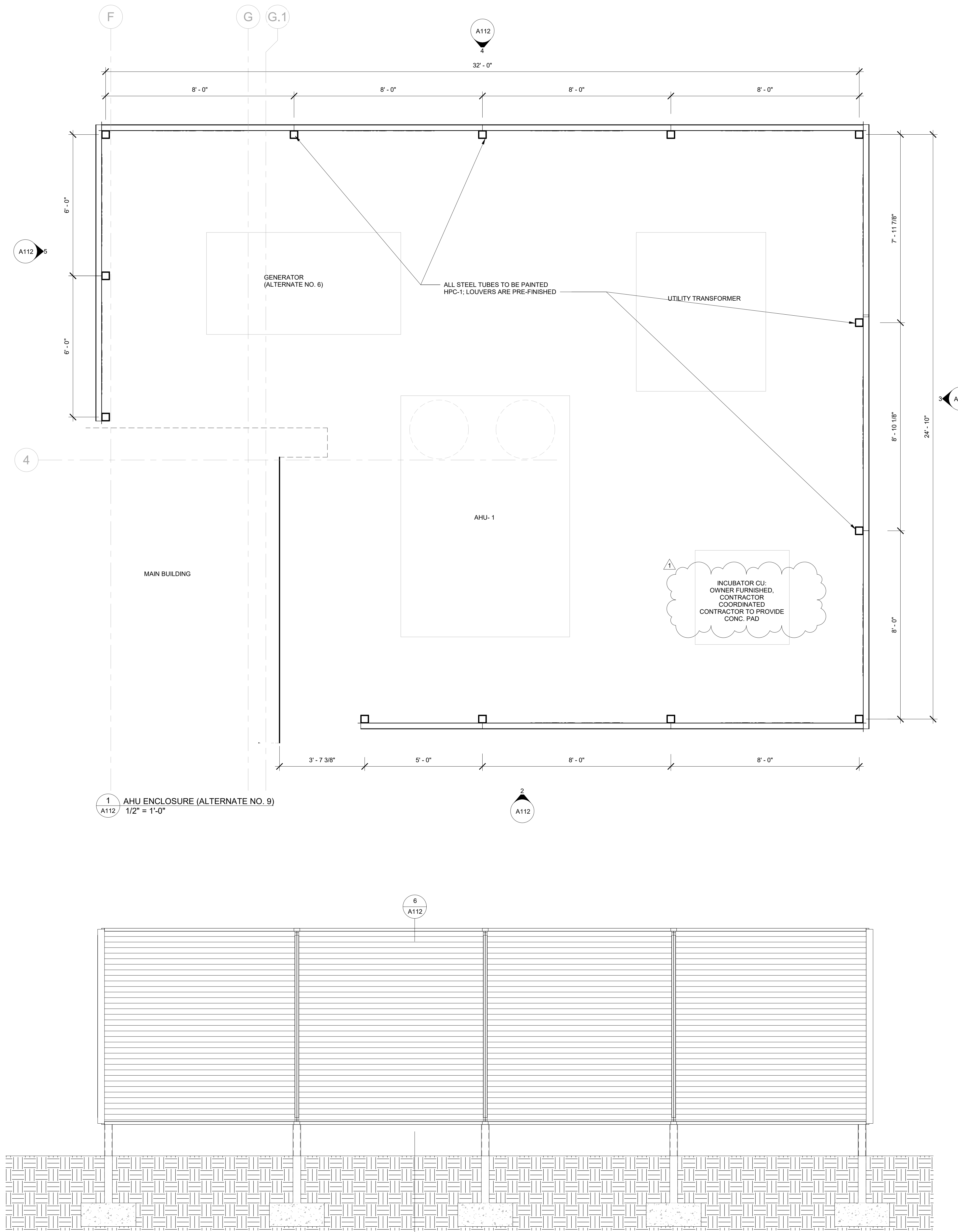

1 AHU ENCLOSURE (ALTERNATE NO. 9)
A112 1/2" = 1'-0"

2 A112

2 ELEVATION
A112 1/2" = 1'-0"

3 ELEVATION (ALTERNATE NO. 9)
A112 1/2" = 1'-0"

4 ELEVATION (ALTERNATE NO. 9)
A112 1/2" = 1'-0"

5 ELEVATION (ALTERNATE NO. 9)
A112 1/2" = 1'-0"

6 LOUVER DETAIL (ALTERNATE NO. 9)
A112 3/4" = 1'-0"

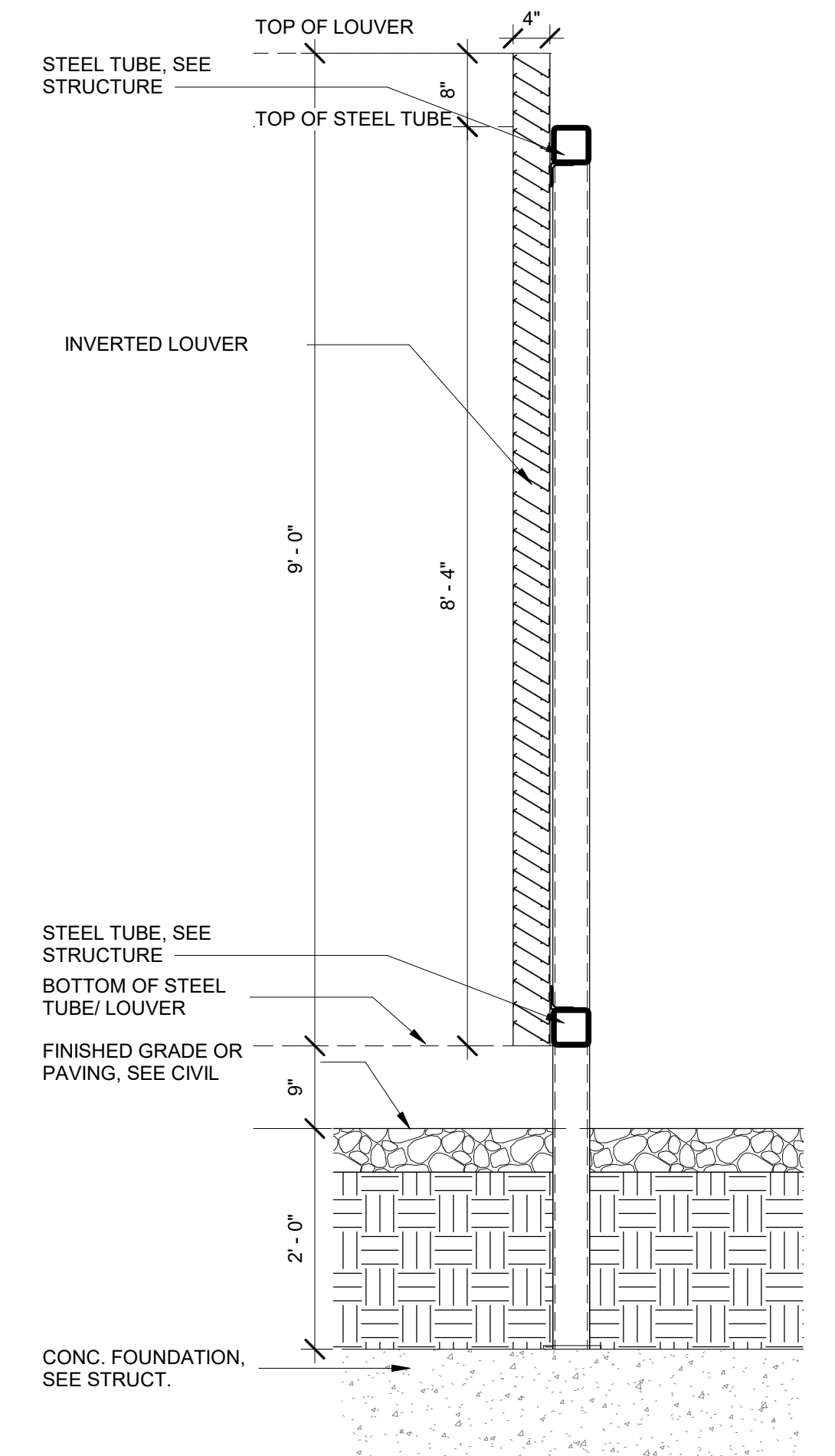
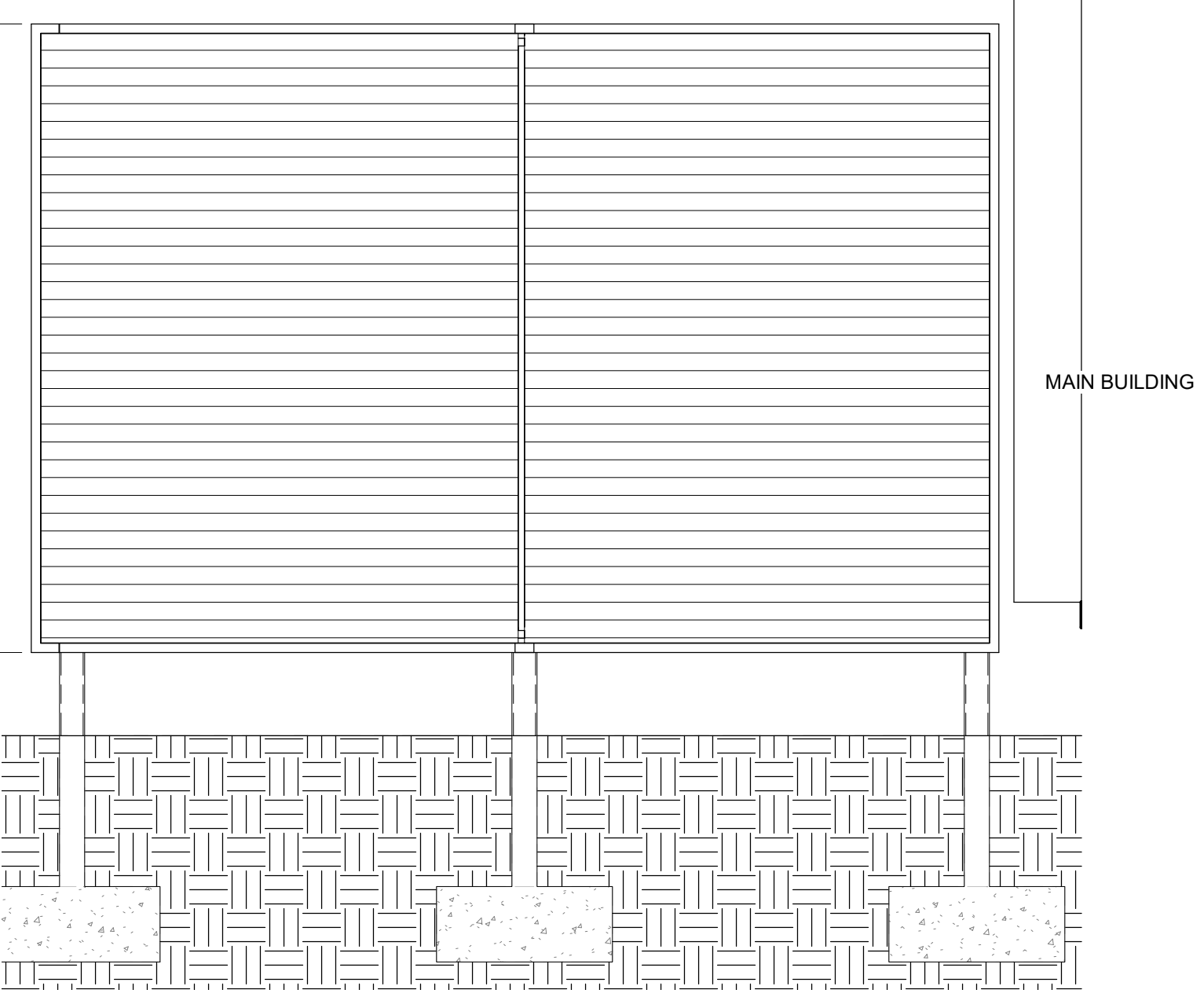
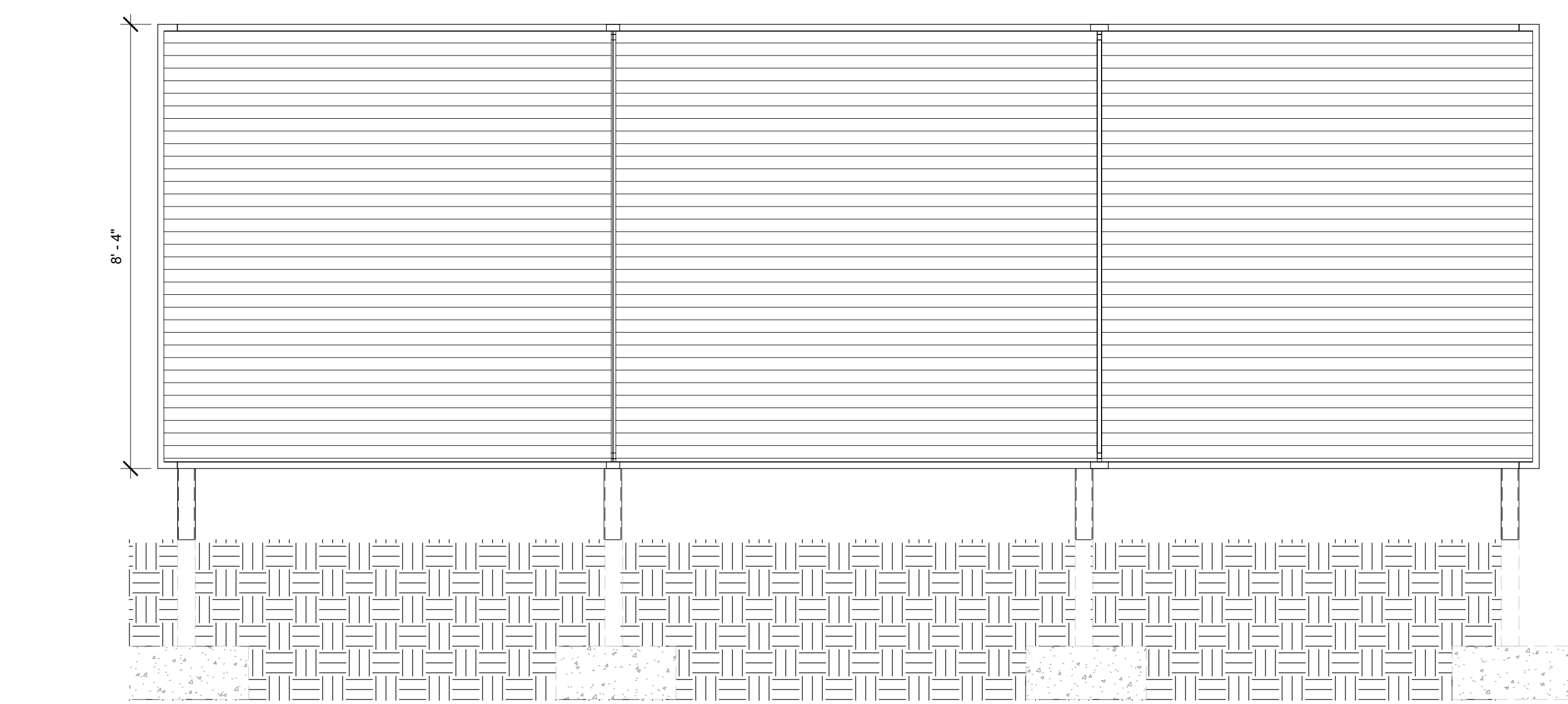
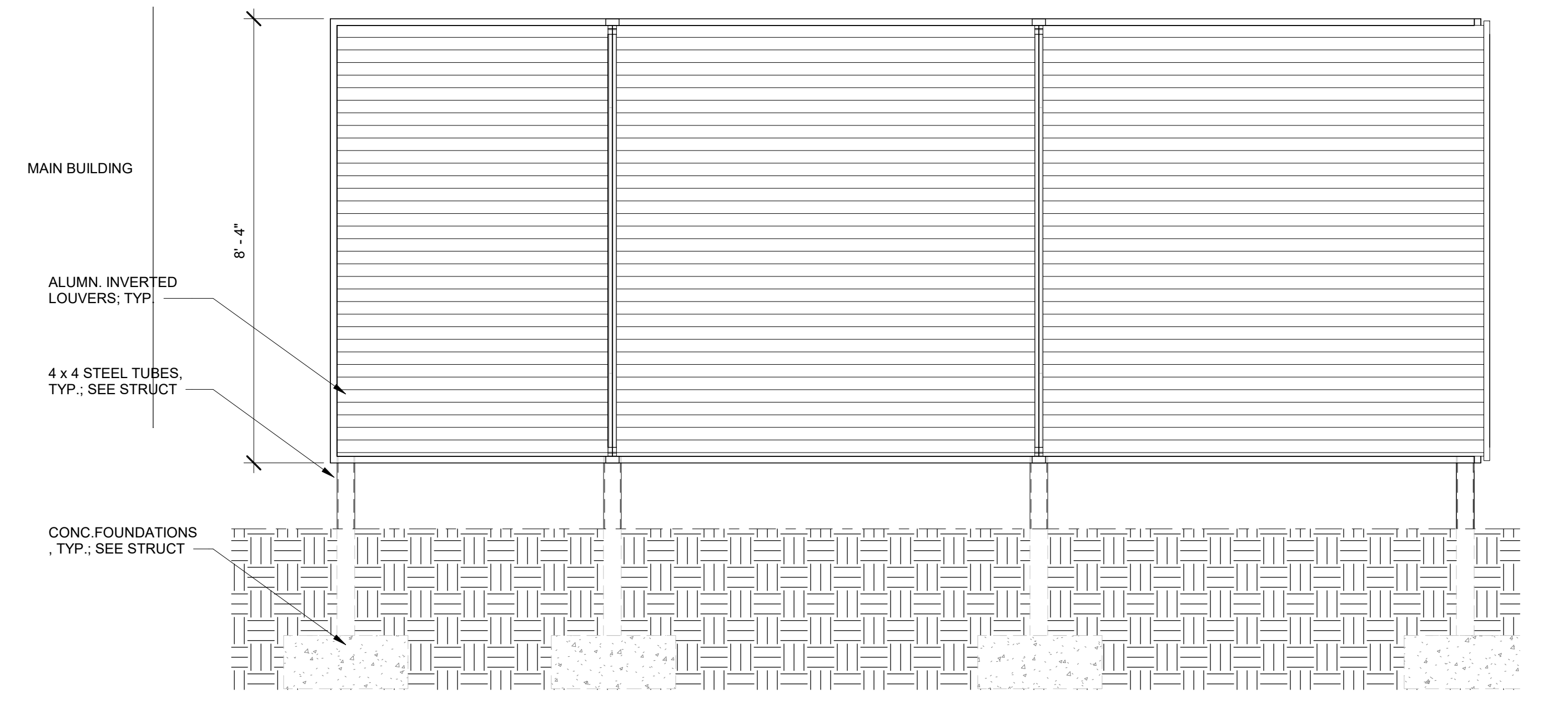

biloba Architecture, PLLC
 think | design
 8801 JM Keynes Drive
 Suite 365
 Charlotte, NC 28262
 704.248.2922
 www.biloba.co

Civil and Structural Engineer, Landscape Architect:
 Stewart Inc.
 Raleigh 223 S. West Street, Suite 1100
 Raleigh, NC 27603
 NC Certificate of Licensure: C-1051

Plumbing, Mechanical, and Electrical Engineer:
 RMP Engineering
 5520 Research Park Drive, Ste 300
 Baltimore, MD 21228
 NC Certificate of Licensure: C-1125

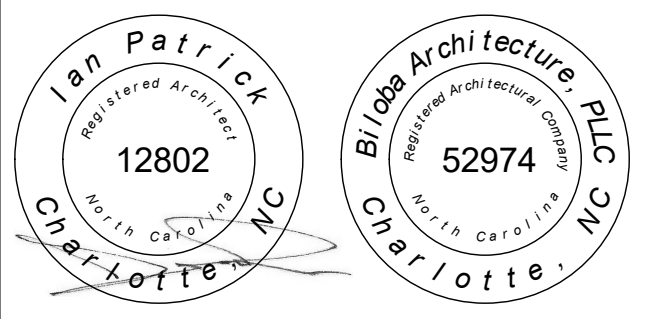

02.07.2025

Drawn	Author
Checked	Checker
Date	01/10/2025
Revisions	
1	02/07/2025 Addendum No. 2

Copyright 2024. All rights reserved. Printed or electronic drawings and documentation may not be reproduced in any form without written permission from Biloba Architecture, PLLC.

NCSU Apiculture Facility
 Raleigh, NC
 SCO ID No.: 22-24494-01A
 Code: 42124 Item: 315
 NCSU: 202220007

Project Number 132
 Title
AHU Enclosure (Alternate No. 9)

Sheet
A112
 Plate

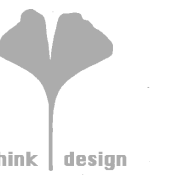

8801 JM Keynes Drive
Suite 365
Charlotte, NC 28262
704.248.2922
www.biloba.co

Civil and Structural Engineer, Landscape Architect:
Stewart Inc.
Raleigh 223 S. West Street, Suite 1100
Raleigh, NC 27603
NC Certificate of Licensure: C-1051

Plumbing, Mechanical, and Electrical Engineer:
RMP Engineering
5520 Research Park Drive, Ste 300
Baltimore, MD 21228
NC Certificate of Licensure: C-1125

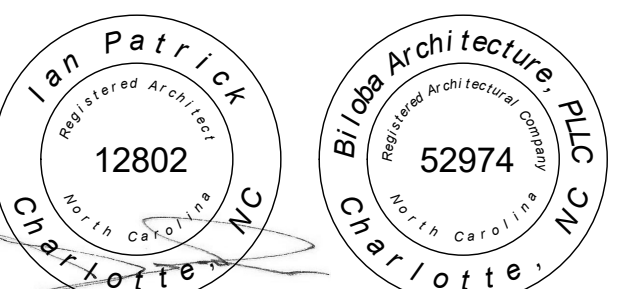

02.07.2025

Drawn	ADO
Checked	IWP
Date	01/10/2025
Revisions	
1	02/07/2025 Addendum No. 2

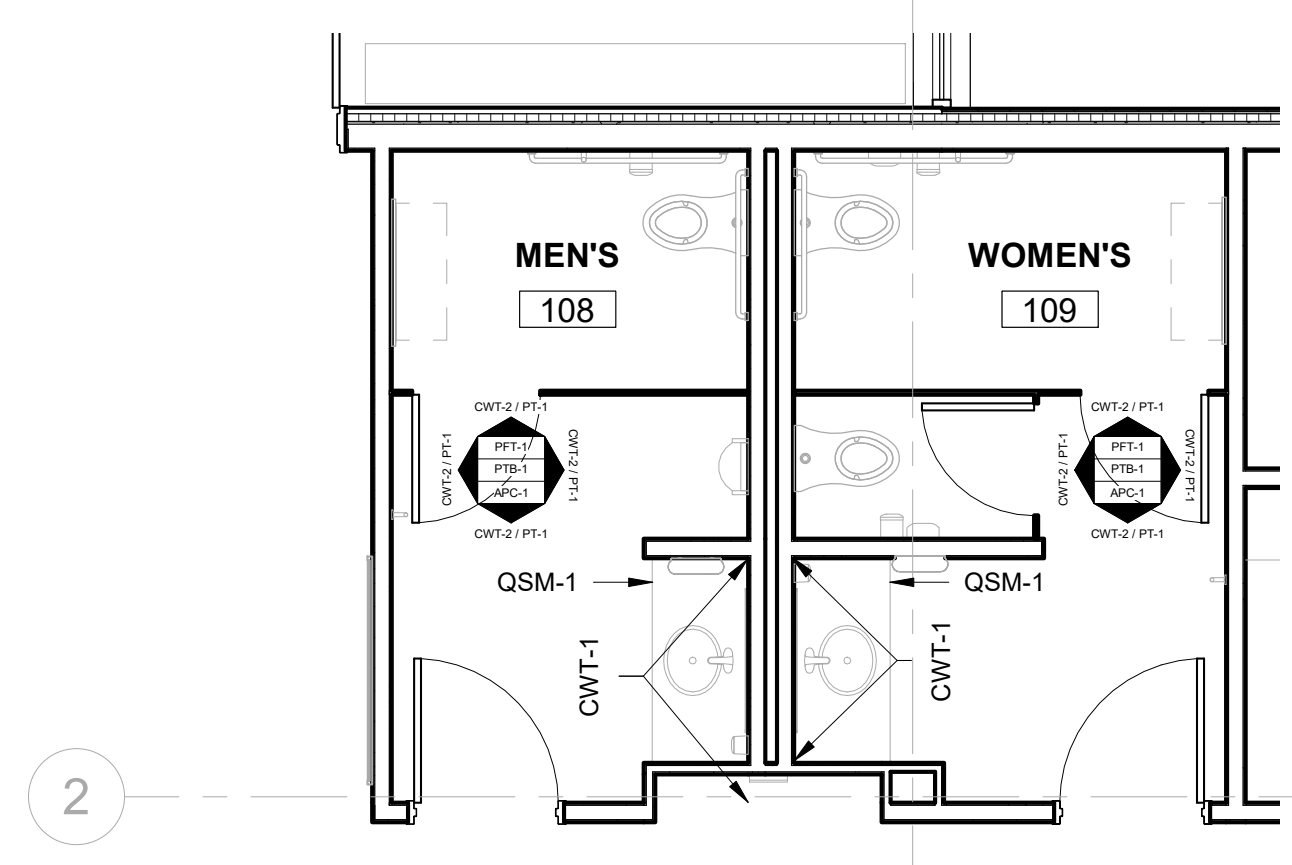
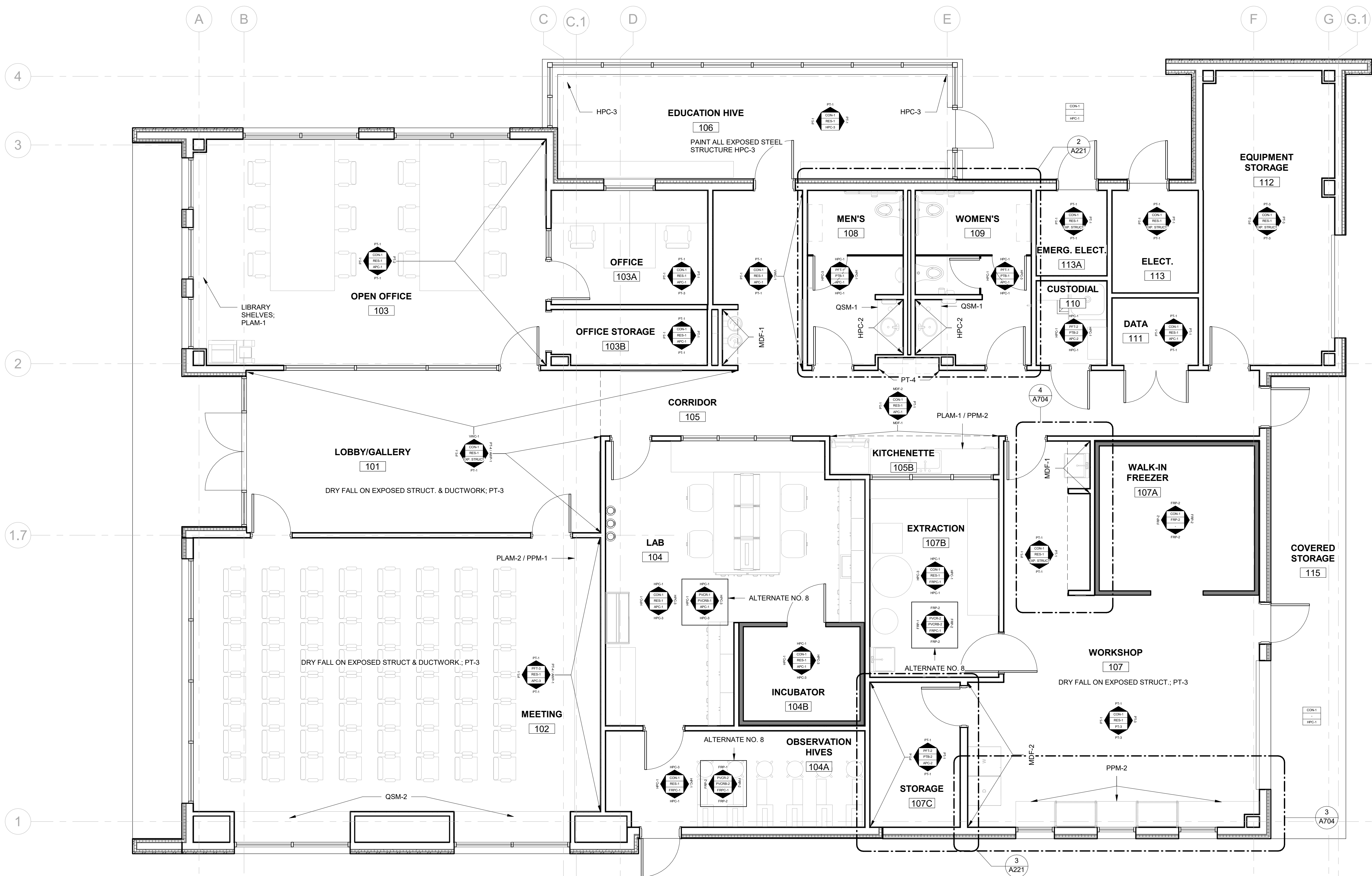

2 FINISH PLAN - ALTERNATE NO. 4
1/4" = 1'-0"

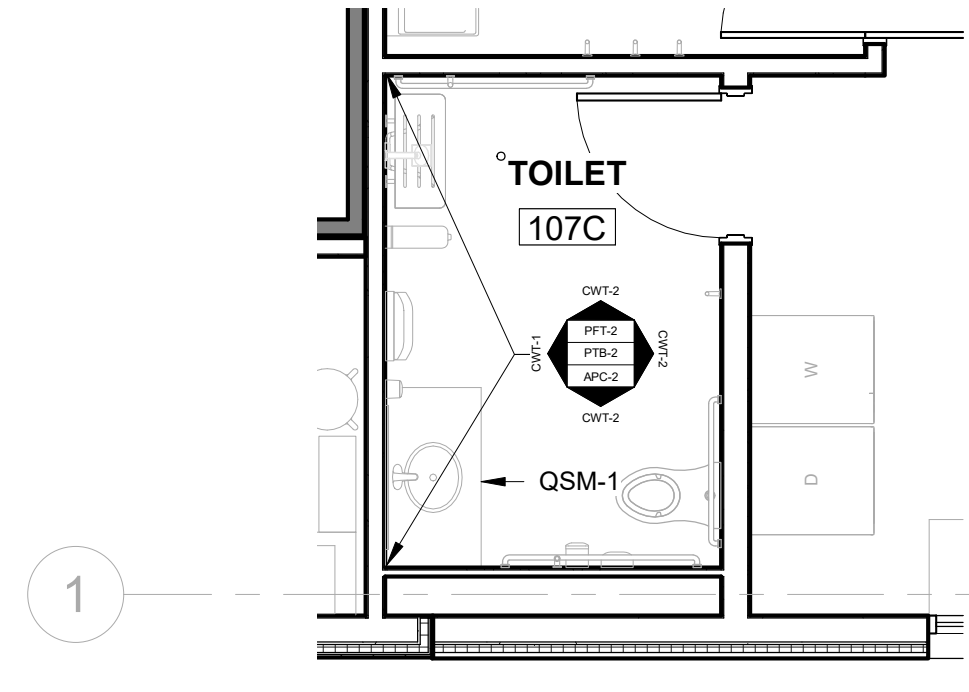

3 FINISH PLAN - ALTERNATE NO. 5
1/4" = 1'-0"

1 FINISH PLAN - ALTERNATE NO. 1
1/4" = 1'-0"

FINISH NOTES

1. ALL INTERIOR FINISHES SHALL COMPLY WITH NC STATE BUILDING CODE CHAPTER 8.
2. MANUFACTURER'S NAME AND STOCK NUMBERS ARE PROVIDED TO IDENTIFY THE PATTERN, COLOR, AND TEXTURE DESIRED (BASIS OF DESIGN). OTHER MANUFACTURERS' PRODUCTS MEETING THE REQUIREMENTS SPECIFIED AND HAVING SIMILAR PATTERN, COLOR AND TEXTURE MAY BE ACCEPTABLE. SEE SPECS FOR LISTING OF ALTERNATE MANUFACTURERS.
3. ALL WALLS TO BE PAINTED PT-1 U.N.O.
4. ALL NEW GYP. BD. CEILINGS TO BE PAINTED PT-1 U.N.O.
5. NOT USED
6. ALL DOOR FRAMES TO BE PAINTED SAME AS ADJACENT WALL COLOR U.N.O.
7. A METAL SCHLUTER STRIP (VINPRO-U IN BRUSHED CHROME, OR APPROVED EQUAL) SHALL BE PROVIDED AT LVT TO CONC FLOOR TRANSITIONS.
8. EXPOSED STRUCTURE AND MECHANICAL TO BE PAINTED IN DRY FOG.

FINISH SYMBOL LEGEND

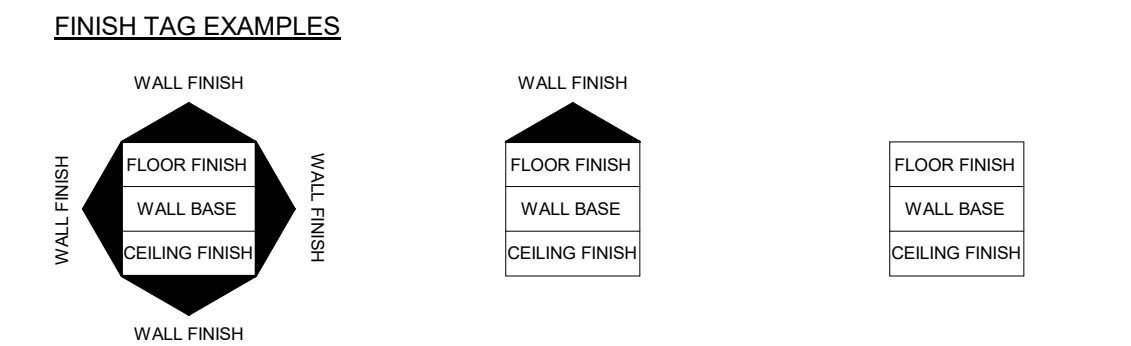

FINISH LEGEND

APC	ACOUSTICAL PANEL CEILING
AWP	ACOUSTICAL WALL PANEL
CON	CONCRETE FLOOR
CNP	CONCRETE FLOOR POLISHED
CWT	CERAMIC WALL TILE
FRP	FIBERGLASS REINFORCED PLASTIC
FRPC	FIBERGLASS REINFORCED PLASTIC CEILING
HPC	HIGH PERFORMANCE COATING
MDF	MEDIUM DENSITY FIBERBOARD WALL PANELS
PT	PAINT
PFT	PORCELAIN FLOOR TILE
PPM	PAPER PHENOLIC MATERIAL
PTB	PORCELAIN TILE BASE
PLAM	PLASTIC LAMINATE
PVCR	POLYVINYL CHLORIDE ROLL
PVCRB	POLYVINYL CHLORIDE ROLL BASE (INTEGRAL)
QSM	QUARTZ SURFACE MATERIAL
RES	RESILIENT RUBBER BASE
SSM	SOLID SURFACE MATERIAL
VWC	VINYL WALL COVERING

WALL FINISH:

PT-1	MATERIAL: PAINT MANUFACTURER: SHERWIN-WILLIAMS PRODUCT NO: SW7004 COLOR: SNOWBOUND GLOSS: EGGSHELL	
PT-2	MATERIAL: PAINT MANUFACTURER: SHERWIN-WILLIAMS PRODUCT NO: SW6682 COLOR: LIME DAY GLOSS: EGGSHELL	
PT-3	MATERIAL: PAINT MANUFACTURER: SHERWIN-WILLIAMS PRODUCT NO: SW6684 COLOR: BEFORE THE STORM GLOSS: EGGSHELL	
PT-4	MATERIAL: PAINT MANUFACTURER: SHERWIN-WILLIAMS PRODUCT NO: SW9685 COLOR: AFTER THE STORM GLOSS: EGGSHELL	
HPC-1	MATERIAL: HIGH PERFORMANCE COATING MANUFACTURER: SHERWIN-WILLIAMS PRODUCT NO: SW7004 COLOR: SNOWBOUND	
HPC-2	MATERIAL: HIGH PERFORMANCE COATING MANUFACTURER: SHERWIN-WILLIAMS PRODUCT NO: SW6683 COLOR: BEE	
HPC-3	MATERIAL: HIGH PERFORMANCE COATING MANUFACTURER: SHERWIN-WILLIAMS PRODUCT NO: SW7069 COLOR: IRON ORE	
FRP-1	MATERIAL: FIBERGLASS REINFORCED PLASTIC MANUFACTURER: CRANE COMPOSITES PRODUCT NO: GLASBOARD COLOR: BLACK FINISH: DIMPLED	ALTERNATE NO. 8
FRP-2	MATERIAL: FIBERGLASS REINFORCED PLASTIC MANUFACTURER: CRANE COMPOSITES PRODUCT NO: GLASBOARD COLOR: WHITE FINISH: DIMPLED	ALTERNATE NO. 8
CWT-1	MATERIAL: CERAMIC WALL TILE MANUFACTURER: UMORE PRODUCT NO: BOLOGNA COLOR: JUNIPER - MIXED FINISH SIZE: HEXAGON MOSAIC	ALTERNATE NO. 4
CWT-2	MATERIAL: CERAMIC WALL TILE MANUFACTURER: UMORE PRODUCT NO: SOLERA COLOR: LACE MATTE SIZE: 2.5' X 16"	ALTERNATE NO. 4
MDF-1	MATERIAL: MEDIUM DENSITY FIBERBOARD WALL PANELS MANUFACTURER: ARCHITECTURAL SYSTEMS, INC. PRODUCT NO: CHIZEL BLACK MDF PANELS COLOR: BLACK - WPFNS06 THICKNESS: 12.5MM	

WALL FINISH (CONTINUED):

MDF-2	MATERIAL: MEDIUM DENSITY FIBERBOARD WALL PANELS MANUFACTURER: ARCHITECTURAL SYSTEMS, INC. PRODUCT NO: CHIZEL WOOD PANELS COLOR: WOOD - WPFNS195 THICKNESS: 12.5MM	
AWP-1	MATERIAL: ACOUSTICAL WALL PANEL MANUFACTURER: ARCHITECTURAL SYSTEMS, INC. PRODUCT NO: WOOD SLAT WALL - ACOUSTICAL COLOR: WALNUT NATURAL WPFV495 THICKNESS: 12.5MM	
VWC-1	MATERIAL: VINYL WALL COVERING MANUFACTURER: DREAMSCAPE WALLS PRODUCT NO: TYPE 1 COMMERCIAL WALLCOVERINGS COLOR: GRAPHIC TBD BY OWNER	
PFT-1	MATERIAL: PORCELAIN FLOOR TILE MANUFACTURER: DAL TILE PRODUCT NO: BEE HIVE MEDLEY COLOR: CUBE POSITIVE P047 SIZE: 8 1/2" X 10" HEXAGON	
PFT-2	MATERIAL: PORCELAIN FLOOR TILE MANUFACTURER: UMORE PRODUCT NO: TIVOLI COLOR: MIDNIGHT SIZE: 10" X 11" HEX MOSAIC	
PFT-3	MATERIAL: PORCELAIN FLOOR TILE MANUFACTURER: DAL TILE PRODUCT NO: ACREAGE COLOR: PALAMINO AC11 SIZE: 9" X 45" MATTE	
PVCR-1	MATERIAL: POLYVINYL CHLORIDE ROLL MANUFACTURER: ALTRO PRODUCT NO: SYMPHONIA COLOR: AYANA SY20034	ALTERNATE NO. 8
PVCR-2	MATERIAL: POLYVINYL CHLORIDE ROLL MANUFACTURER: ALTRO PRODUCT NO: SYMPHONIA COLOR: FESTUCA SY20010 SIZE: 6" (INTEGRAL COVE BASE)	ALTERNATE NO. 8
CON-1	MATERIAL: CONCRETE FLOOR FINISH: SEALED	
PCON-1	MATERIAL: CONCRETE FLOOR FINISH: POLISHED	ALTERNATE NO. 7
RES-1	MATERIAL: RESILIENT RUBBER BASE MANUFACTURER: JOHNSONITE PRODUCT NO: BASEWORKS THERMOSET RUBBER (TYPE TS) COLOR: 48 GREY SIZE: 6"	
PTB-1	MATERIAL: PORCELAIN TILE BASE MANUFACTURER: DAL TILE PRODUCT NO: COLOR WHEEL LINEAR COLOR: MATTE ARCTIC WHITE SIZE: 4" X 12" FLAT TOP COVE BASE	

WALL BASE (CONTINUED):

PTB-2	MATERIAL: PORCELAIN TILE BASE MANUFACTURER: UMORE PRODUCT NO: TIVOLI COLOR: MIDNIGHT SIZE: 4" CUT TILE BASE (USE SCHLUTER DILEX-AHK IN SATIN NICKEL AT)	
PVCRB-1	MATERIAL: POLYVINYL CHLORIDE ROLL BASE MANUFACTURER: ALTRO PRODUCT NO: SYMPHONIA COLOR: AYANA SY20034 SIZE: 6" (INTEGRAL COVE BASE)	ALTERNATE NO. 8
PVCRB-2	MATERIAL: POLYVINYL CHLORIDE ROLL BASE MANUFACTURER: ALTRO PRODUCT NO: SYMPHONIA COLOR: FESTUCA SY20010 SIZE: 6" (INTEGRAL COVE BASE)	ALTERNATE NO. 8
APC-1	MATERIAL: ACOUSTICAL PANEL CEILING MANUFACTURER: ARMSTRONG PRODUCT NO: CALLA 690 COLOR: WHITE SIZE: 2' X 2' X 1"	
APC-2	MATERIAL: ACOUSTICAL PANEL CEILING MANUFACTURER: ARMSTRONG PRODUCT NO: CERAMAGUARD 605 COLOR: WHITE SIZE: 2' X 4' X 5/8"	
APC-3	MATERIAL: ACOUSTIC PET MATERIAL CEILING MANUFACTURER: ALTRSPACE PRODUCT NO: ACOUSTIC SHAPES, HEXAGON COLOR: WHITE SIZE: 30" X 30" X 2"	
FRPC-1	MATERIAL: FIBERGLASS REINFORCED PLASTIC CEILING MANUFACTURER: NIUDO PRODUCT NO: FIBERLITE FRP COLOR: WHITE 151 SIZE: 24" X 24" FINISH: SMOOTH	
PLAM-1	MATERIAL: PLASTIC LAMINATE MANUFACTURER: FENIX PRODUCT NO: FENIX NTM COLOR: NERO INGO J0720 FINISH: MATTE - THROUGH COLOR	
PLAM-2	MATERIAL: PLASTIC LAMINATE MANUFACTURER: FENIX PRODUCT NO: FENIX NTM COLOR: BLU FES J0754 FINISH: MATTE - THROUGH COLOR	
PPM-1	MATERIAL: PAPER PHENOLIC MATERIAL MANUFACTURER: RICHIE PRODUCT NO: CASCADE COLOR: HOOD (HONED FINISH)	

MILLWORK / COUNTERTOPS (CONTINUED):

PPM-2	MATERIAL: PAPER PHENOLIC MATERIAL MANUFACTURER: RICHIE PRODUCT NO: STRATUM COLOR: BAMBOO BLACK DIAMOND (HONED FINISH)
QSM-1	MATERIAL: QUARTZ SURFACE MATERIAL MANUFACTURER: CORIAN PRODUCT NO: QUARTZ SURFACE COLOR: PORTORO
QSM-2	MATERIAL: QUARTZ SURFACE MATERIAL MANUFACTURER: CORIAN PRODUCT NO: QUARTZ SURFACE COLOR: SNOW WHITE

EXTERIOR FINISH NOTES

1. SEE EXTERIOR ELEVATIONS FOR METAL PANEL COLOR LOCATIONS.
- RED STANDING SEAM METAL ROOF: METAL ROOFING SYSTEMS, INC. - REGAL RED
- RED METAL FASCIA: MBCI - SIGNATURE 300 BRITE RED
- RED METAL PANEL: MBCI DESIGNER SERIES FLUTED - SIGNATURE 300 BRITE RED
- BROWN METAL TRIM: MBCI - SIGNATURE 200 KOKO BROWN
- WHITE METAL PANEL: MBCI DESIGNER SERIES FLUTED - SIGNATURE 300 BONE WHITE
- RED METAL GUTTER WITH RAINCHAINS: MBCI - SIGNATURE 300 BRITE RED
- TIMBER CLADDING: RESAWN TIMBER CO. - ACCOYA WATSON 1C
- AHU ENCLOSURE: MBCI - SIGNATURE 200 KOKO BROWN

ALTERNATES LEGEND

ALTERNATE NO. 1A	OWNER PREFERRED DOOR HARDWARE
ALTERNATE NO. 1B	OWNER PREFERRED BRAND CONTROLLER
ALTERNATE NO. 1C	OWNER PREFERRED CONTROLS
ALTERNATE NO. 1D	OWNER PREFERRED CONTROLS
ALTERNATE NO. 2	BARN QUILT CUSTOM PANELS
ALTERNATE NO. 3	MOVEABLE GLASS WALL
ALTERNATE NO. 4	CERAMIC WALL TILE (BASE BID - HIGH PERFORMANCE COATING HPC-1)
ALTERNATE NO. 5	TOILET ROOM 107C (BASE BID - STORAGE ROOM 107C)
ALTERNATE NO. 6	EMERGENCY GENERATOR
ALTERNATE NO. 7	POLISHED CONCRETE (BASE BID - UNPOLISHED CONCRETE)
ALTERNATE NO. 8	FRP AND PVC ROLL PRODUCT FLOORING (BASE BID - HIGH PERFORMANCE COATING HPC-1 AND UNPOLISHED CONCRETE FLOOR CON-1)
ALTERNATE NO. 9	AHU SCREENING (BASE BID - OMIT SCREENING)
ALTERNATE NO. 10	EXISTING HOUSE & SEPTIC DEMOLITION
ALTERNATE NO. 11	LAB CASEWORK (BASE BID - OMIT LAB CASEWORK)

Copyright 2024. All rights reserved. Printed or electronic drawings and documentation may not be reproduced in any form without written permission from Biloba Architecture, PLLC.

NCSU Apiculture Facility

Raleigh, NC
SCO ID No.: 22-24494-01A
Code: 42124 Item: 315
NCSU: 202220007

Project Number 132

Finish Plan and Notes

Sheet

A221

Plate

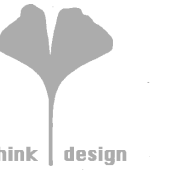

8801 JM Keynes Drive
Suite 365
Charlotte, NC 28262
704.248.2922
www.biloba.co

Civil and Structural Engineer, Landscape Architect:
Stewart Inc.
Raleigh 223 S. West Street, Suite 1100
Raleigh, NC 27603
NC Certificate of Licensure: C-1051

Plumbing, Mechanical, and Electrical Engineer:
RMP Engineering
5520 Research Park Drive, Ste 300
Baltimore, MD 21228
NC Certificate of Licensure: C-1125

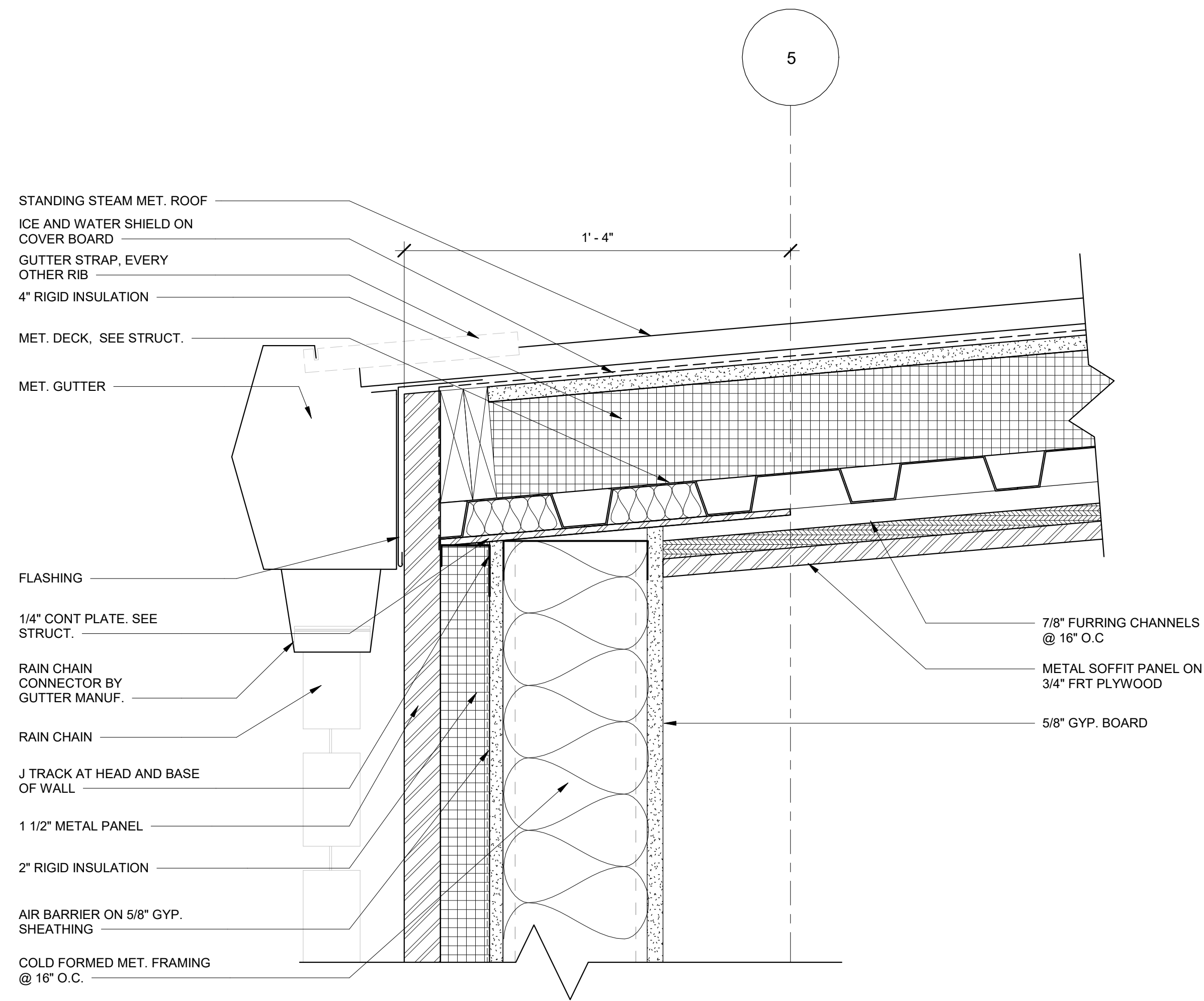

2 ROOF DETAIL
A503 3" = 1'-0"

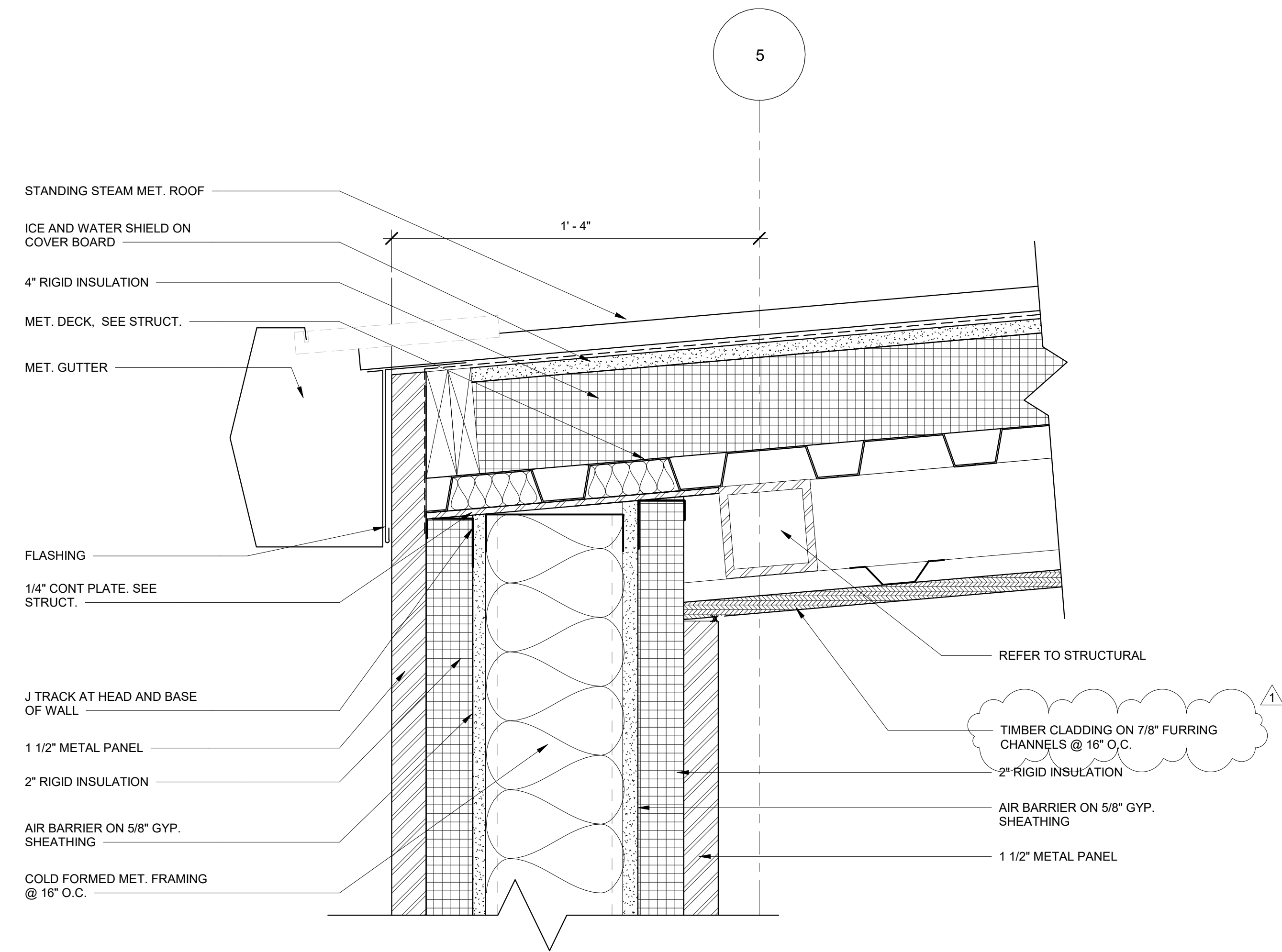

3 ROOF DETAIL
A503 3" = 1'-0"

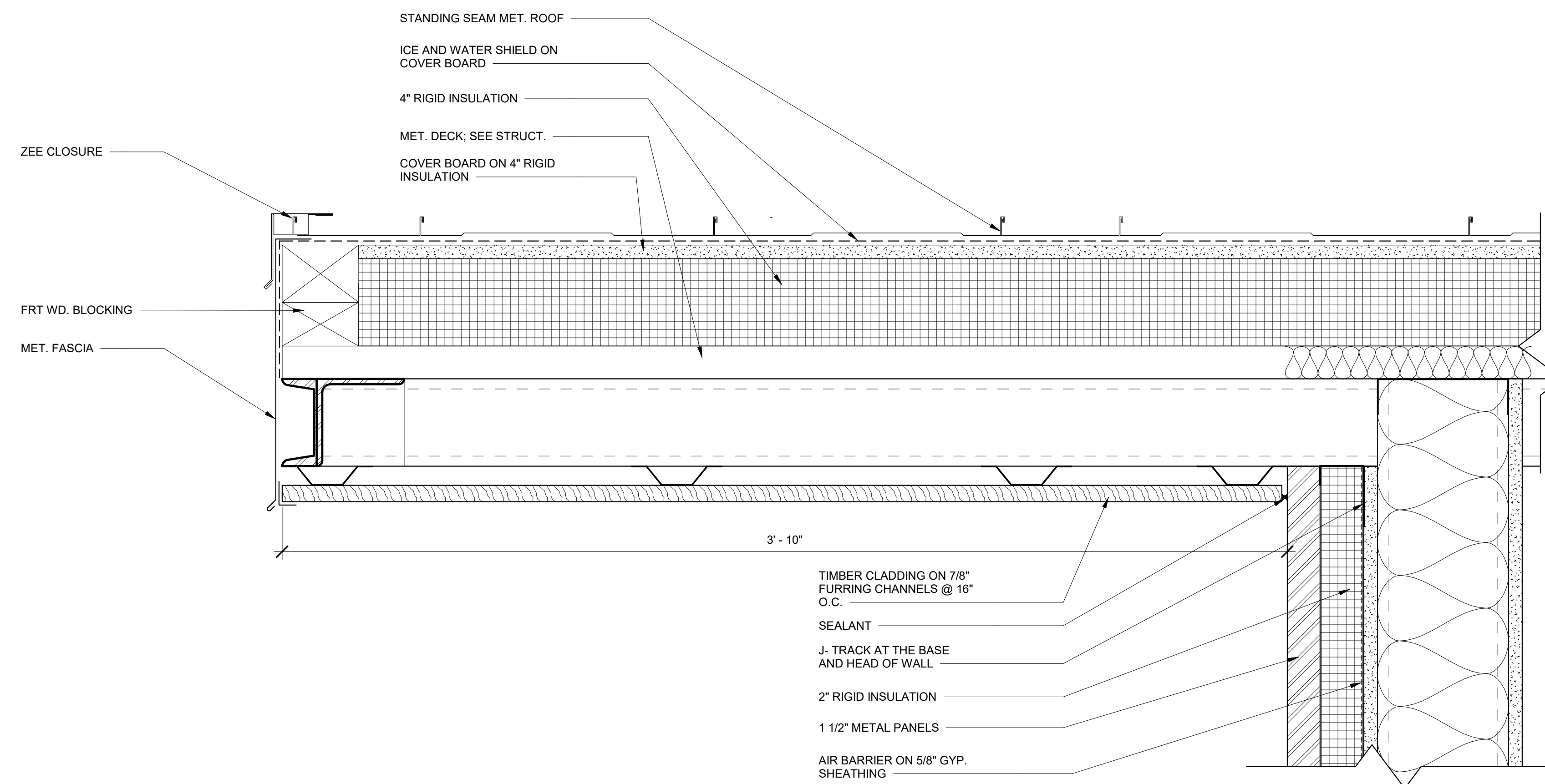

1 ROOF DETAIL
A503 3" = 1'-0"

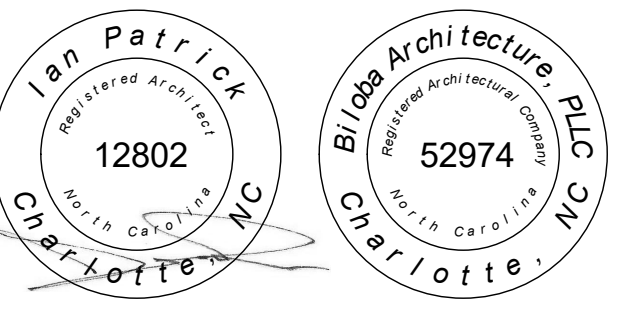

02.07.2025
Drawn HRK
Checked IWP
Date 01/10/2025
Revisions
1 02/07/2025 Addendum No. 2

Copyright 2024. All rights reserved. Printed or electronic drawings and documentation may not be reproduced in any form without written permission from Biloba Architecture, PLLC.

NCSU Apiculture Facility
Raleigh, NC
SCO ID No.: 22-24494-01A
Code: 42124 Item: 315
NCSU: 202220007

Project Number 132
Title
Roof Details

Sheet
A503
Plate

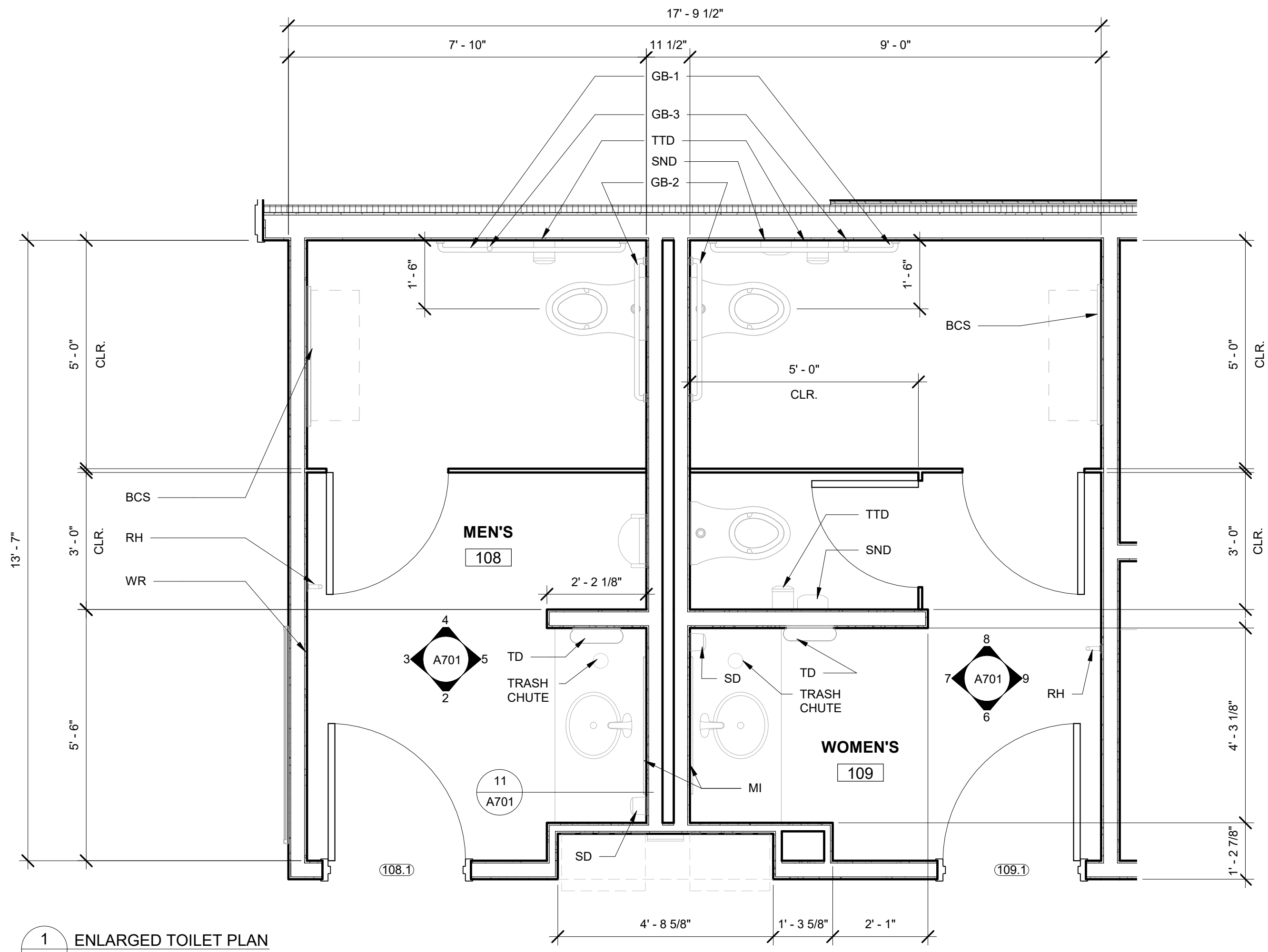

- TOILET AND BATH ACCESSORY LEGEND**
- BCS BABY CHANGING STATION
 - GB-1 GRAB BAR, 48"
 - GB-2 GRAB BAR, 36"
 - GB-3 GRAB BAR, 18"
 - GB-4 GRAB BAR, 24"
 - MI MIRROR, WALL MOUNTED
 - SND SOAP DISPENSER, WALL MOUNTED
 - TTD TISSUE DISPENSER
 - TD TOILET TISSUE DISPENSER
 - UTILITY / COAT / ROBE HOOK
 - WR WASTE RECEPTACLE AND TOWEL DISPENSER, RECESSED
 - SCR SHOWER CURTAIN ROD

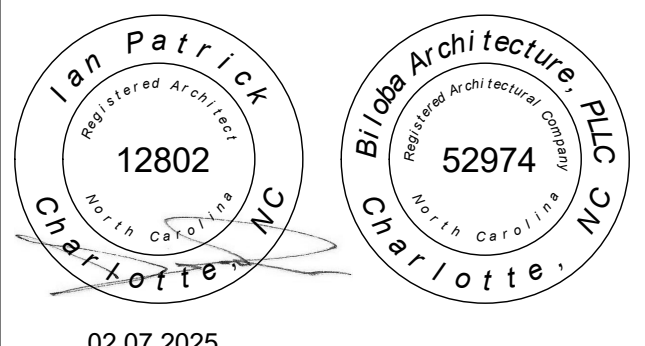
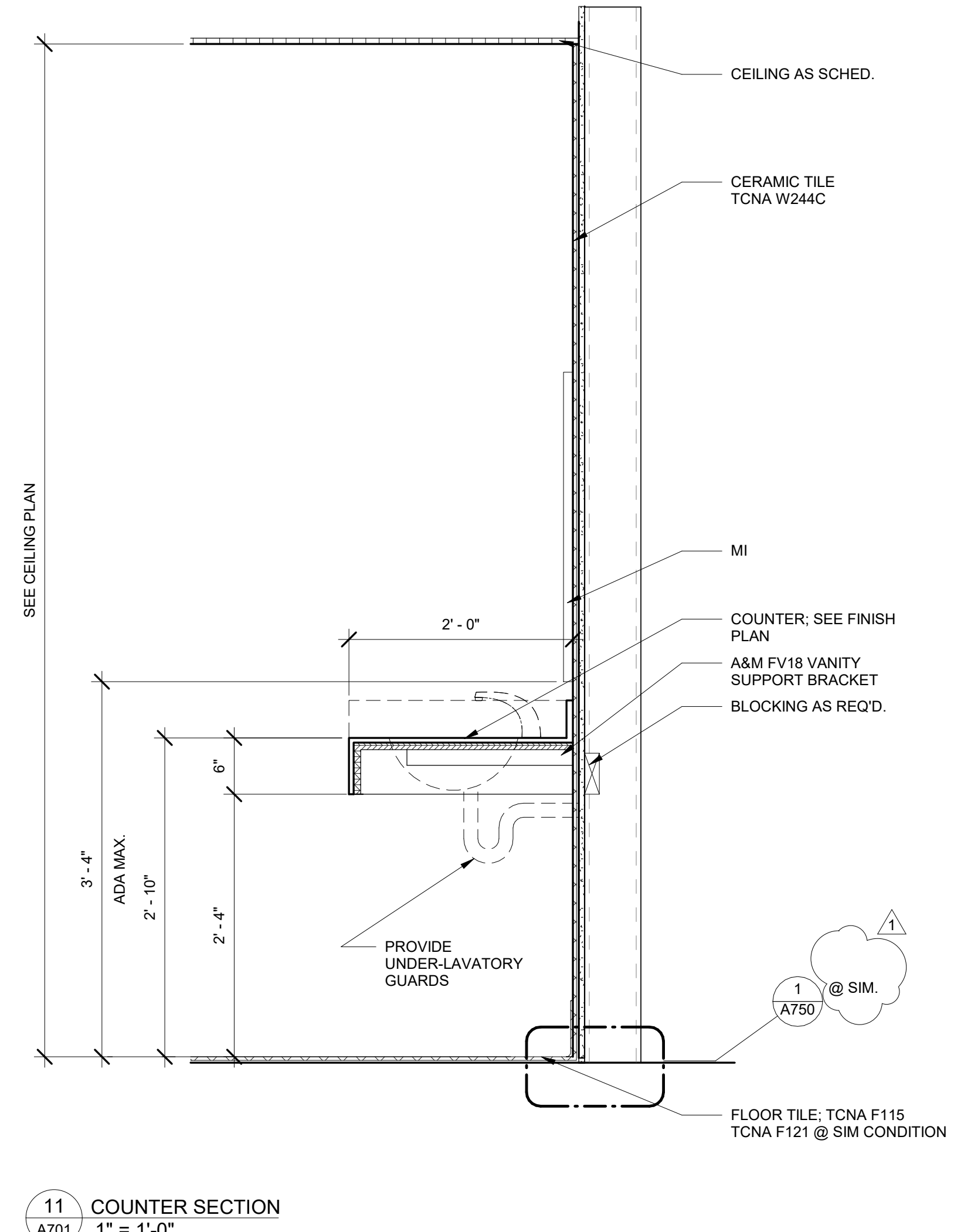
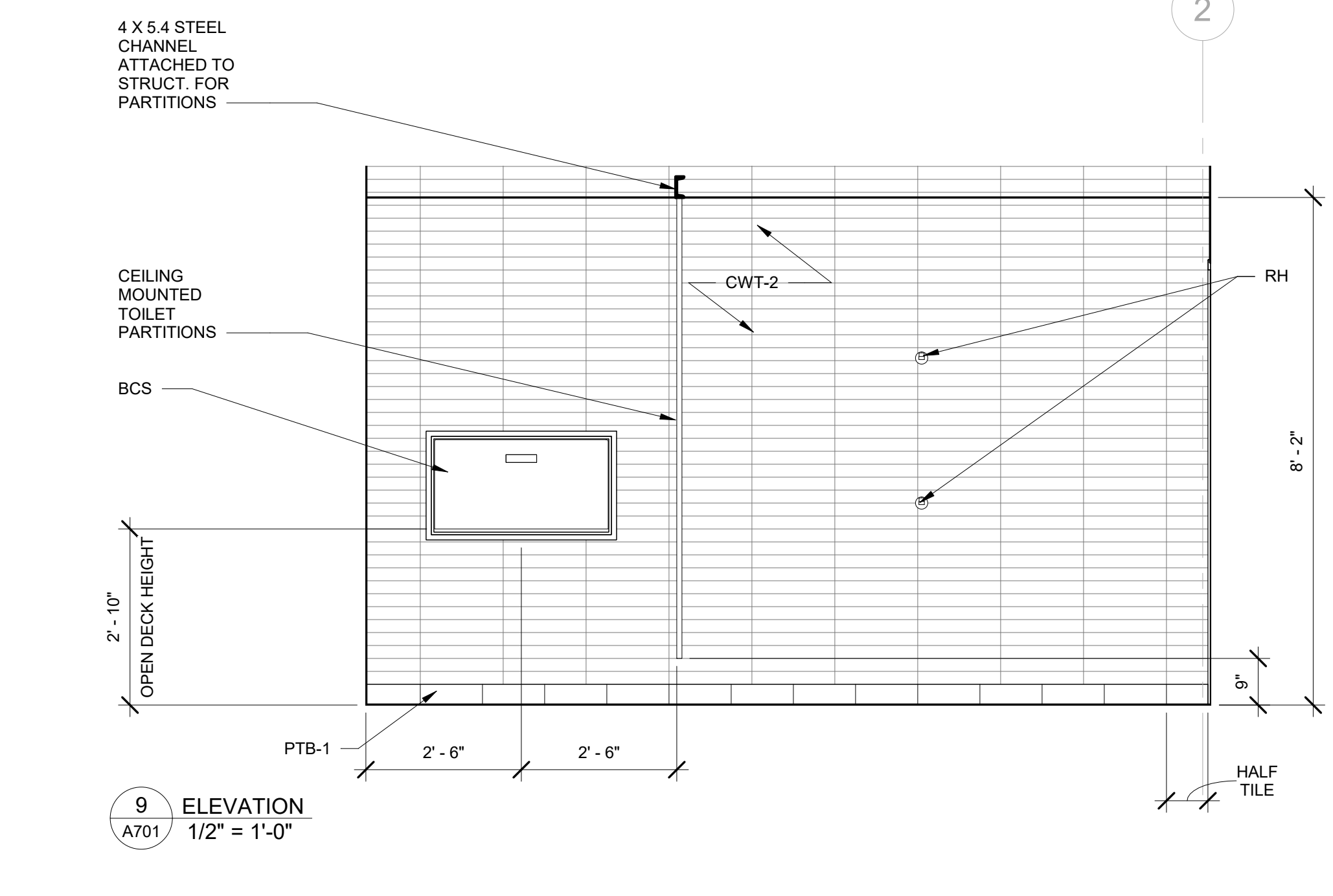
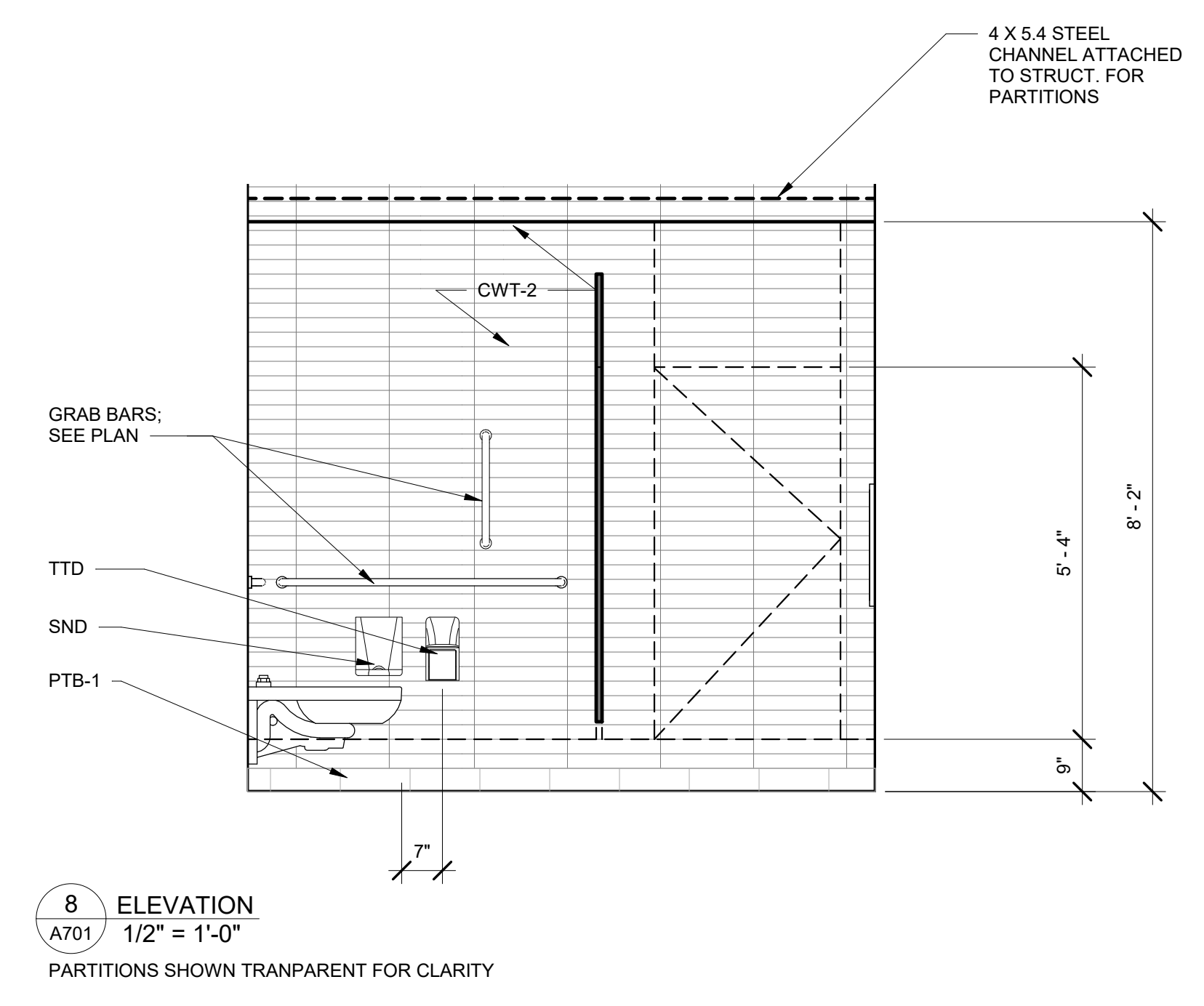
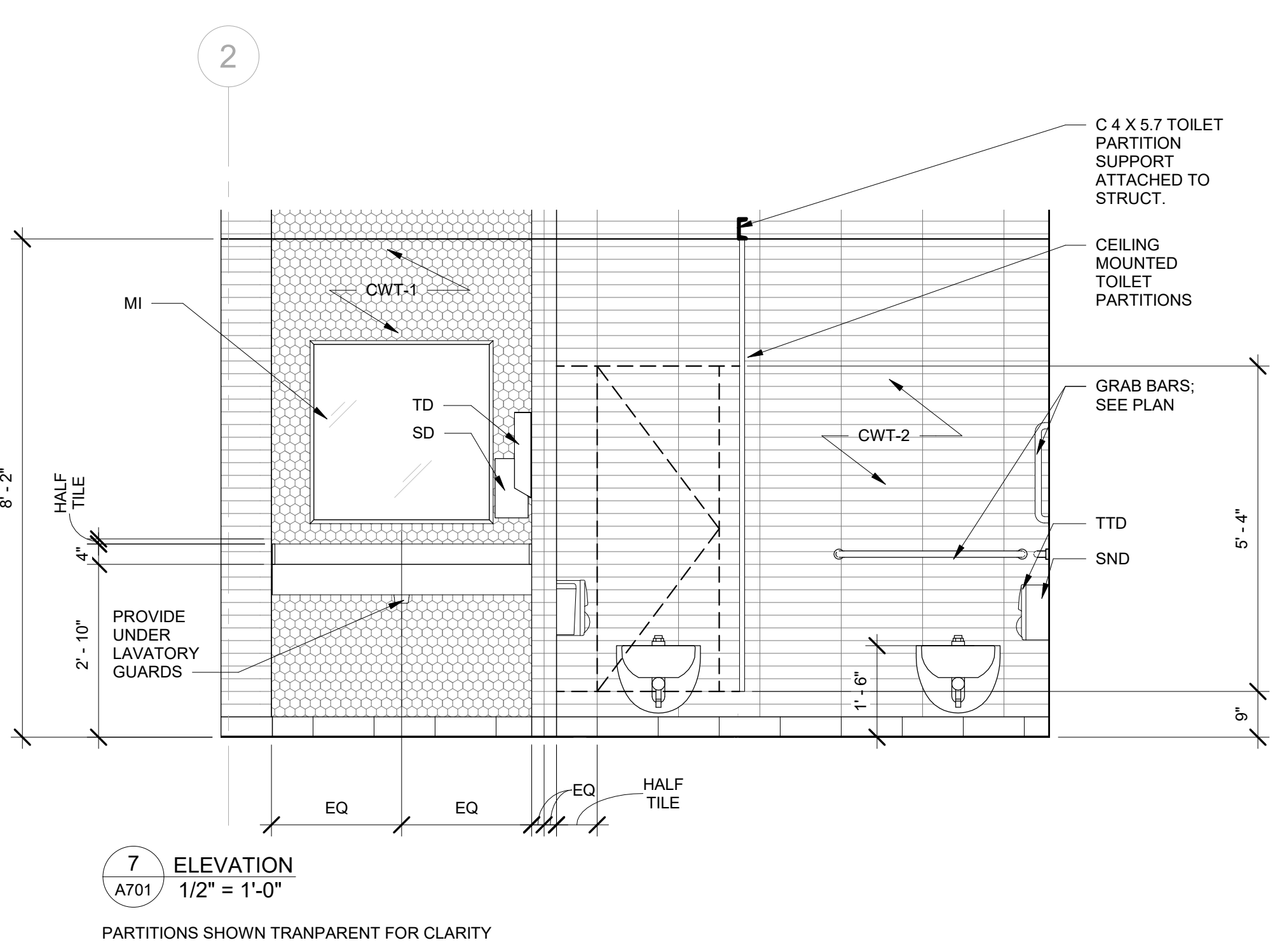
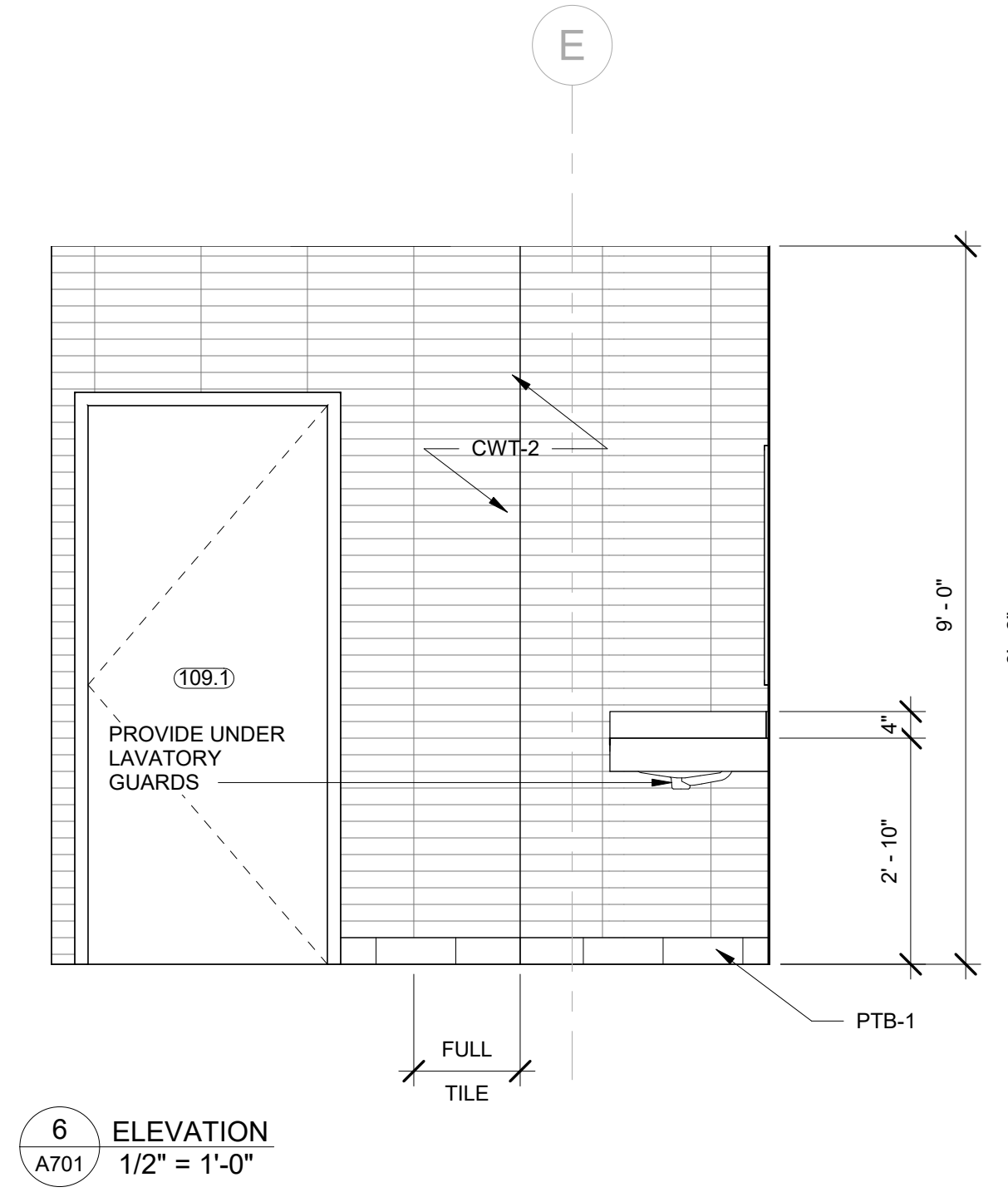
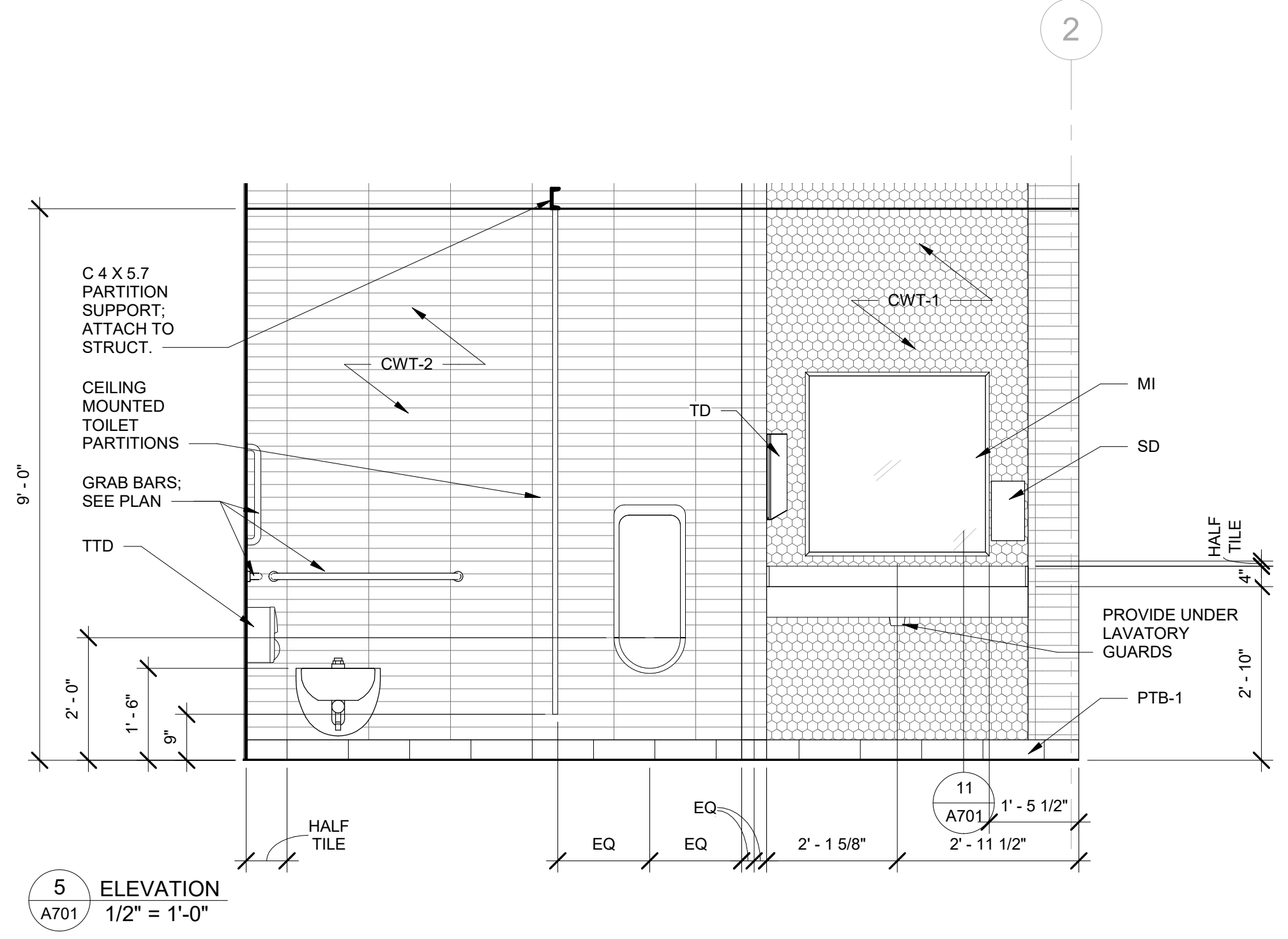
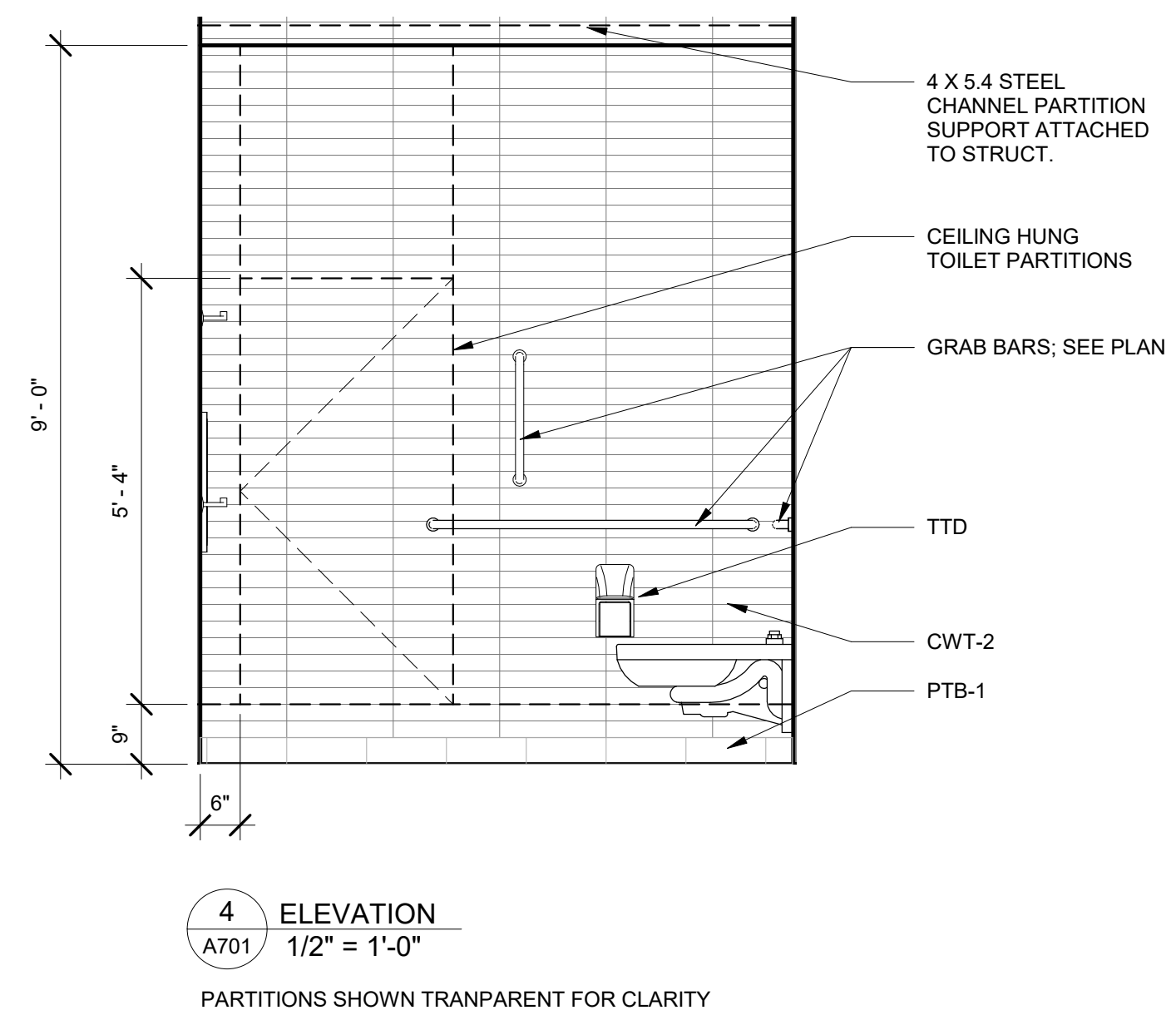
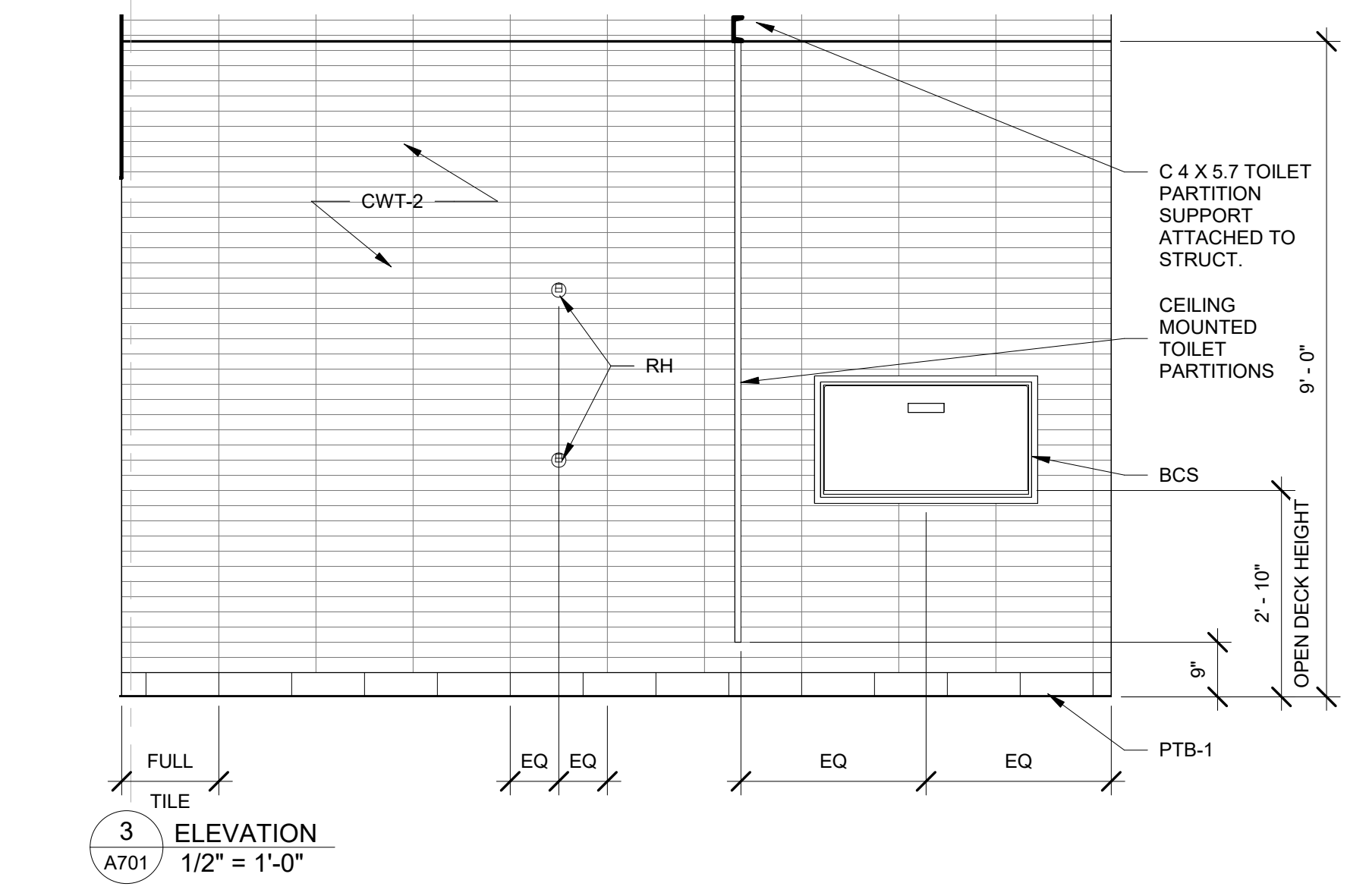
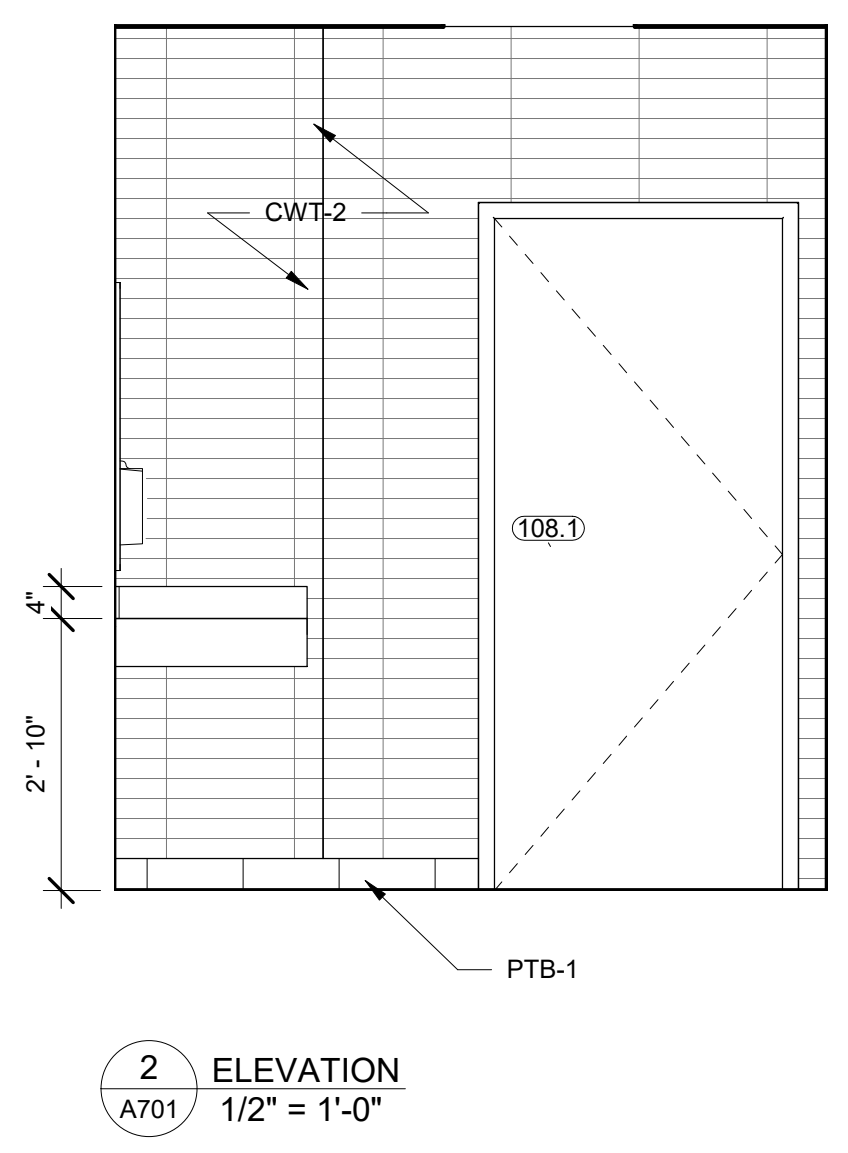
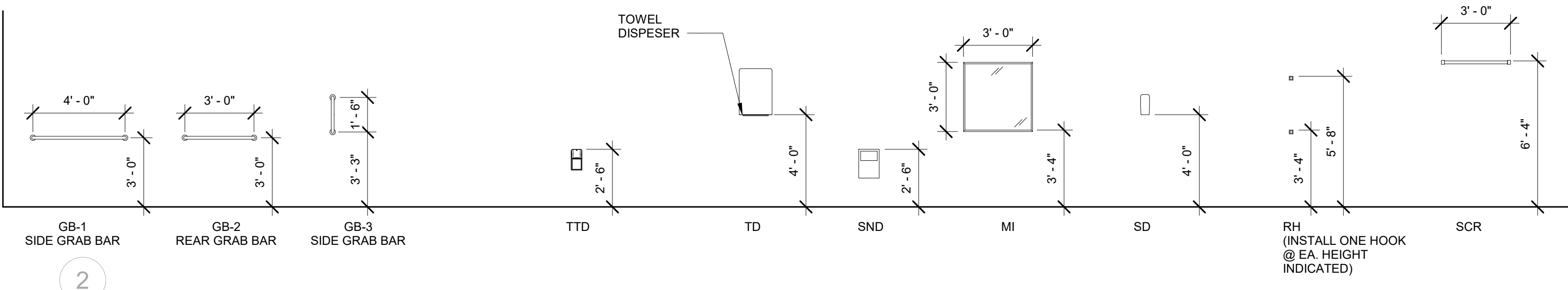

Drawn	Author
Checked	Checker
Date	01/10/2025
Revisions	
1	02/07/2025 Addendum No. 2

Copyright 2024. All rights reserved. Printed or electronic drawings and documentation may not be reproduced in any form without written permission from Biloba Architecture, PLLC.

NCSU Apiculture Facility
 Raleigh, NC
 SCO ID No.: 22-24494-01A
 Code: 42124 Item: 315
 NCSU: 202220007

Project Number 132
 Title
Interior Elevations and Details

Sheet
A701
 Plate

- DRAWING NOTES**
- 1 BASIS OF DESIGN FOR POLE LIGHT, FIXTURE TYPE P1 IS LITHONIA DSX1-LED-P4-40K-80CRI-T3M-MVOLT-SPA-DBLXD. BASIS OF DESIGN FOR POLE SHALL BE LITHONIA SSS-QS-25-4G-DM49AS-DBLXD. ACCEPTABLE ALTERNATES SHALL HAVE SIMILAR CHARACTERISTICS. FIXTURE SHALL BE CONNECT TO RP1-46 AND CONTROLLED THROUGH THE TIME CLOCK RELAY.
 - 2 PROVIDE 12"X12" HAND HOLE FOR PULL POINT FROM INTERIOR PANEL.
 - 3 TELECOM DUCTBANK TO INWOOD ROAD.
 - 4 PRIMARY DUCTBANK TO DUKE ENERGY TRANSFORMER.

biloba Architecture, PLLC
 think | design
 8801 JM Keynes Drive
 Suite 365
 Charlotte, NC 28262
 704.248.2922
 www.biloba.co

Civil and Structural Engineer:
 Stewart Inc.
 Raleigh 223 S. West Street, Suite 1100
 Raleigh, NC 27603
 NC Certificate of Licensure: C-1051

Plumbing, Mechanical, and Electrical Engineer:
 RMP Engineering
 8720 Red Oak Blvd Dr Suite 370
 Charlotte, NC 28217
 NC Certificate of Licensure: C-1126



BID SET

Drawn	TMW
Checked	KLP
Date	1/10/2025
Revisions	
2	2/7/2025 Addendum No. 2

Copyright 2023. All rights reserved. Printed or electronic drawings and documentation may not be reproduced in any form without written permission from Biloba Architecture, PLLC.

NCSU Apiculture Facility
 Raleigh, NC
 SCO ID No.: 22-24494
 Code: 42124 Item: 315
 NCSU: 20222007

Project Number 132
 Title
ELECTRICAL SITE PLAN
 Sheet
E101
 Plate

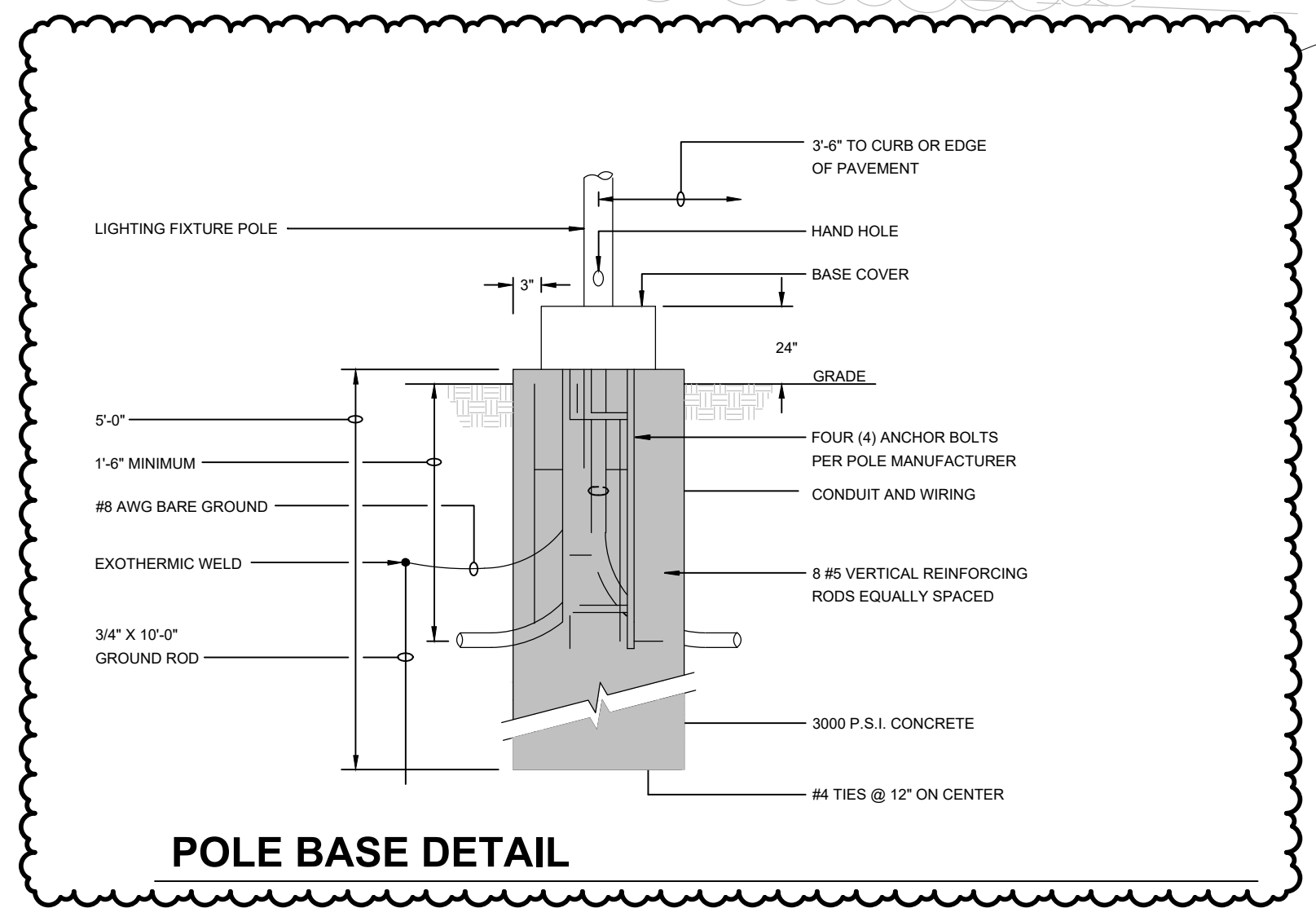

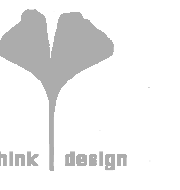
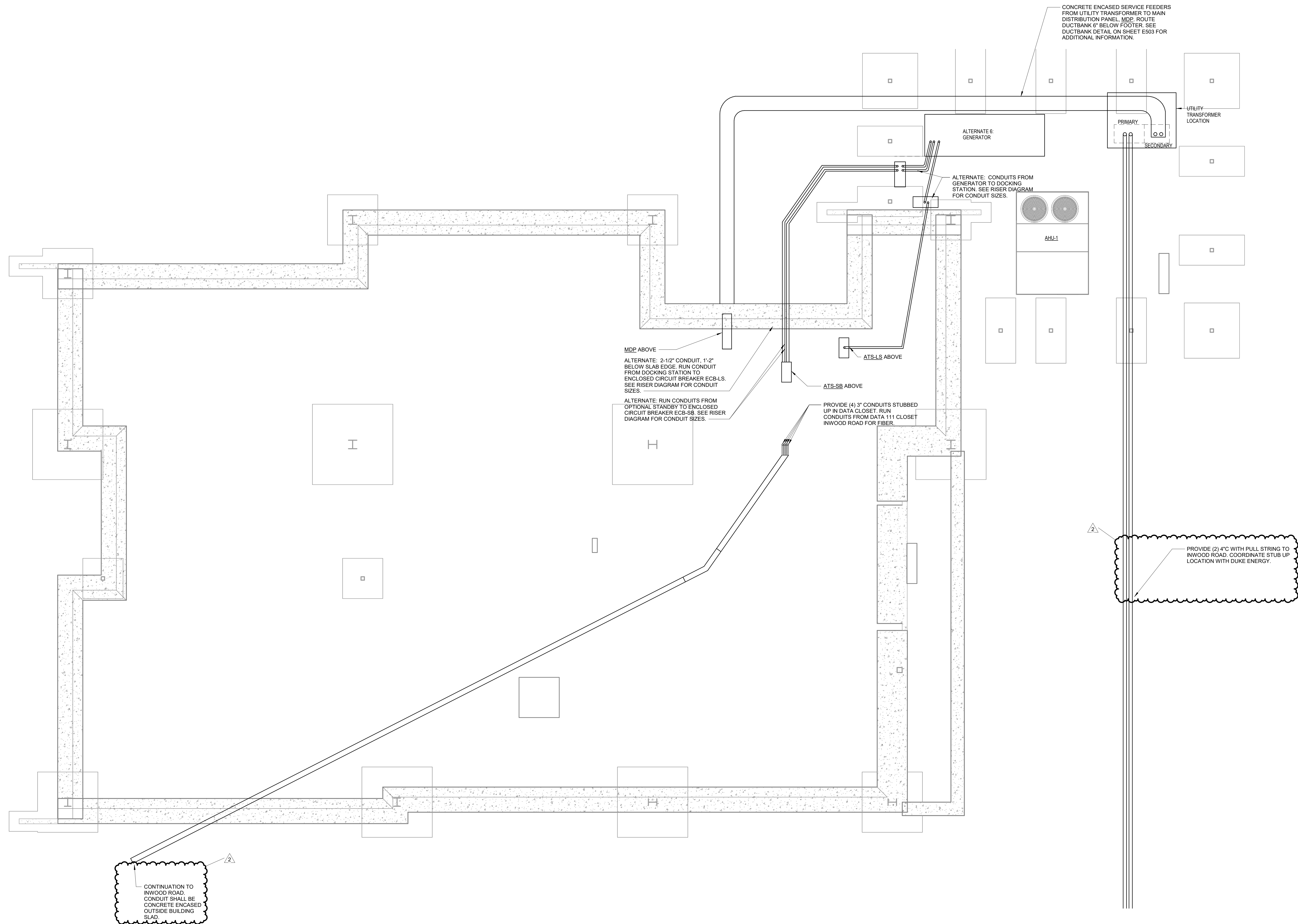

8801 JM Keynes Drive
Suite 365
Charlotte, NC 28262
704.248.2922
www.biloba.co

Civil and Structural Engineer:
Stewart Inc.
Raleigh 223 S. West Street, Suite 1100
Raleigh, NC 27603
NC Certificate of Licensure: C-1051

Plumbing, Mechanical, and Electrical Engineer:
RMF Engineering
8720 Red Oak Blvd Dr Suite 370
Charlotte, NC 28217
NC Certificate of Licensure: C-1126

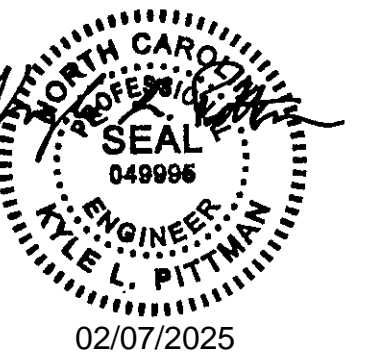

BID SET

Drawn	TMW
Checked	KLP
Date	1/10/2025
Revisions	
2	2/7/2025 Addendum No. 2

Copyright 2023. All rights reserved. Printed or electronic drawings and documentation may not be reproduced in any form without written permission from Biloba Architecture, PLLC.

NCSU Apiculture Facility
Raleigh, NC
SCO ID No.: 22-24494
Code: 42124 Item: 315
NCSU: 20222007

Project Number 132

ELECTRICAL UNDER SLAB PLAN

Sheet

E102

Plate

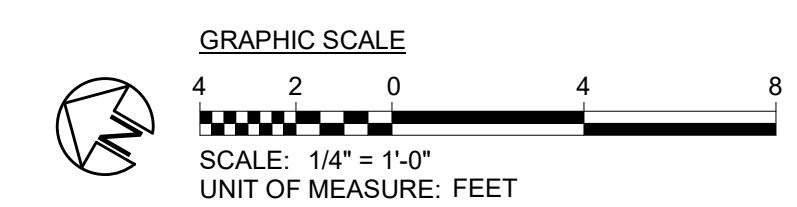

GENERAL NOTES

A. SEE SHEET E701 FOR MOTOR AND EQUIPMENT CONNECTIONS.

DRAWING NOTES

- 1 CONDUITS FROM HANDHOLE OUTSIDE OF BUILDING FOR FIBER SERVICE.
- 2 PROVIDE POWER FOR SECURITY PANEL. COORDINATE MOUNTING HEIGHT AND EXACT PLACEMENT IN FIELD WITH SECURITY INSTALLER.
- 3 PROVIDE 3/4" THICK, FIRE-RETARDANT PLYWOOD ON WALLS FROM FLOOR TO 8'-0" AFF.
- 4 PROVIDE EPO SWITCH FOR GENERATOR.
- 5 PROJECTOR RECEPTACLE SHALL BE MOUNTED ABOVE FLOATING CEILING. COORDINATE PROJECTOR LOCATION AND MOUNTING WITH NCSU CLASSTECH.
- 6 COORDINATE PROJECTOR LOCATION AND MOUNTING WITH NCSU CLASSTECH.
- 7 GRINDER PUMP LOCATED OUTSIDE BUILDING. COORDINATE LOCATION AND PUMP SIZE WITH CIVIL DRAWINGS.
- 8 MICROWAVE RECEPTACLE SHALL BE MOUNTED 24" AFF. COORDINATE ROUGH-IN LOCATION WITH ARCHITECTURAL ELEVATIONS.
- 9 ALTERNATE 6: PROVIDE 3/4" FROM GENERATOR TO GENERATOR ANNUNCIATOR PANEL (GAP). PROVIDE 2#14 TWISTED SHIELDED PAIR WIRE OR MANUFACTURER SPECIFIED WIRE.

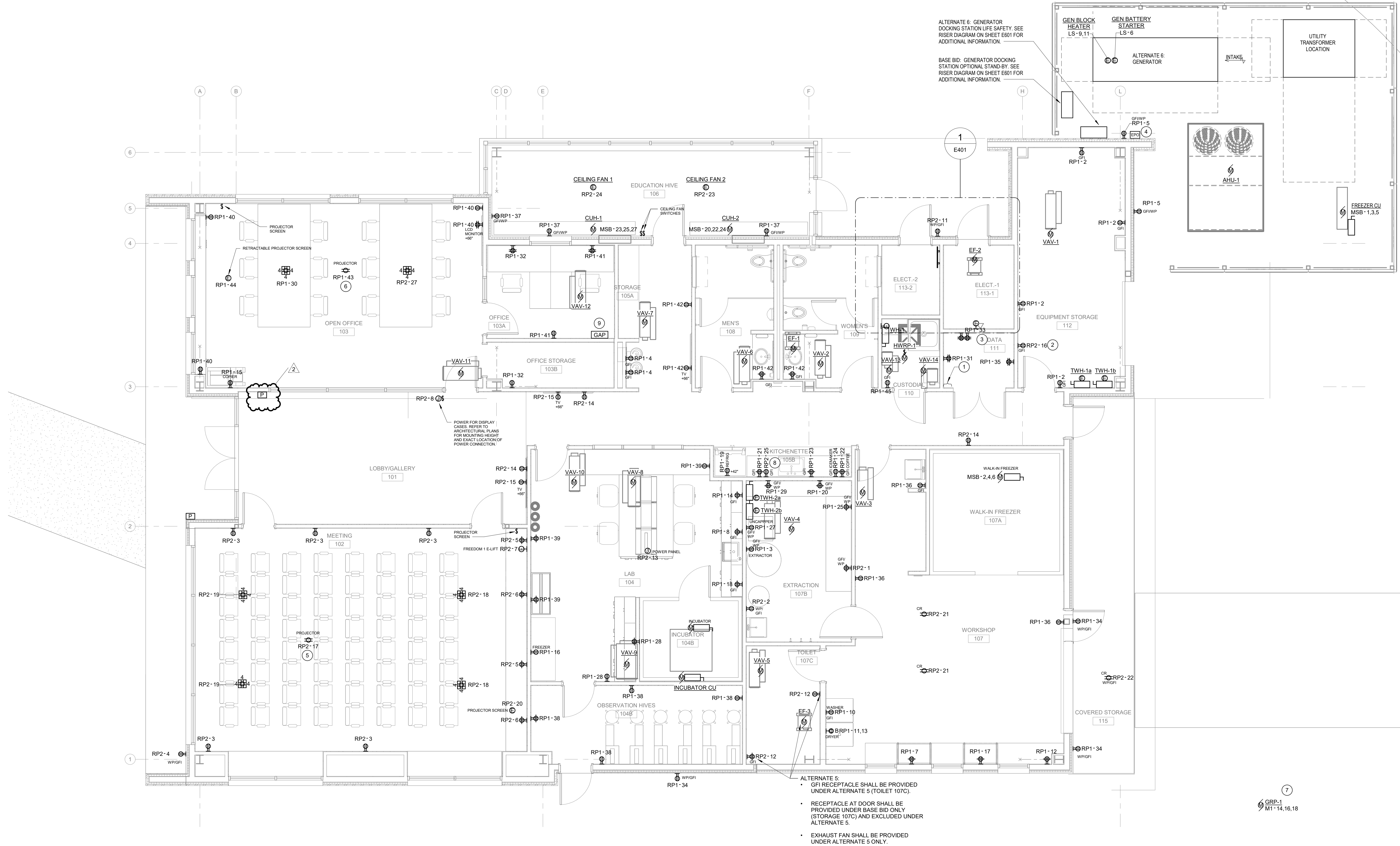

biloba Architecture, PLLC

8801 JM Keynes Drive
Suite 365
Charlotte, NC 28262
704.248.2922
www.biloba.co

Civil and Structural Engineer:
Stewart Inc.
Raleigh 223 S. West Street, Suite 1100
Raleigh, NC 27603
NC Certificate of Licensure: C-1051

Plumbing, Mechanical, and Electrical Engineer:
RMP Engineering
8720 Red Oak Blvd Dr Suite 370
Charlotte, NC 28217
NC Certificate of Licensure: C-1126

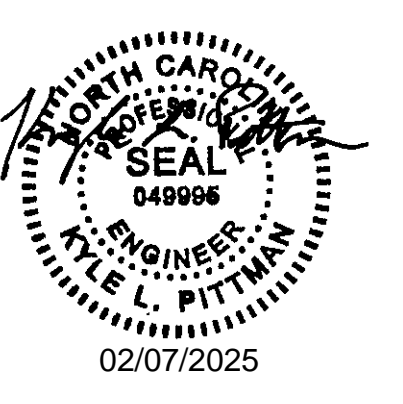

BID SET

Drawn	TMW
Checked	KLP
Date	1/10/2025
Revisions	
2	2/7/2025 Addendum No. 2

Copyright 2023. All rights reserved. Printed or electronic drawings and documentation may not be reproduced in any form without written permission from Biloba Architecture, PLLC.

NCSU Apiculture Facility
Raleigh, NC
SCO ID No.: 22-24494
Code: 42124 Item: 315
NCSU: 202220007

Project Number 132
Title **POWER FLOOR PLAN**

Sheet **E111**
Plate

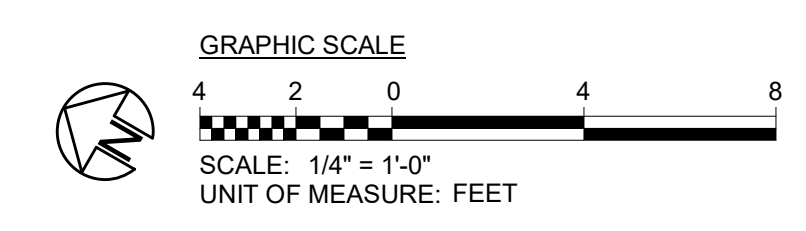

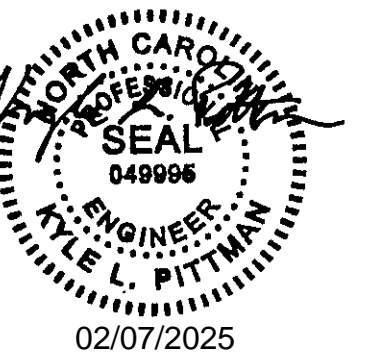
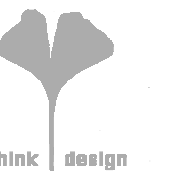

BID SET

Drawn	KLP
Checked	KLP
Date	1/10/2025
Revisions	
2	2/7/2025 Addendum No. 2

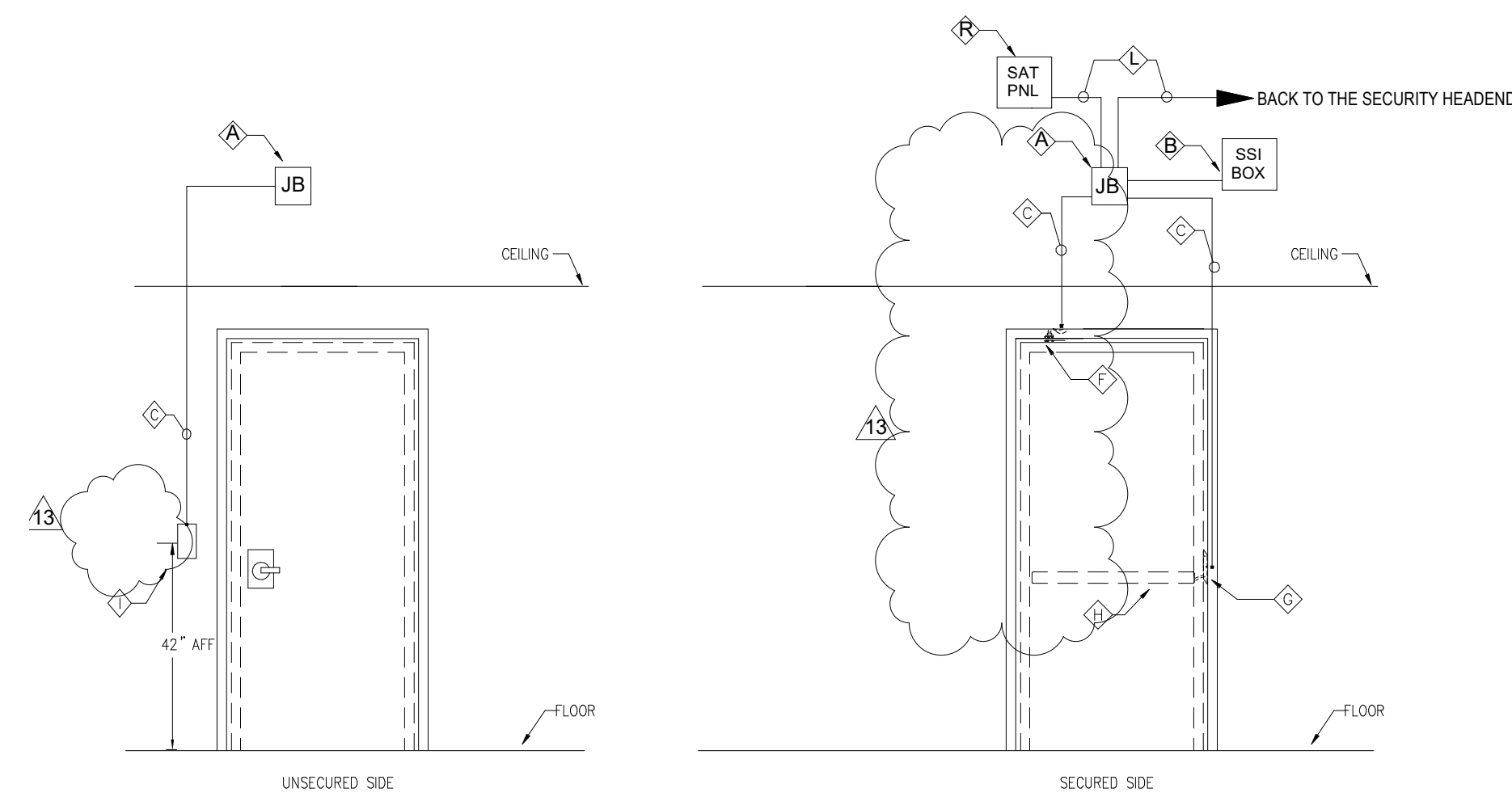

1 INTERIOR SINGLE DOOR WITH (1) CARD READER, ELECTRIFIED EXIT DETAIL
Scale: N.T.S.

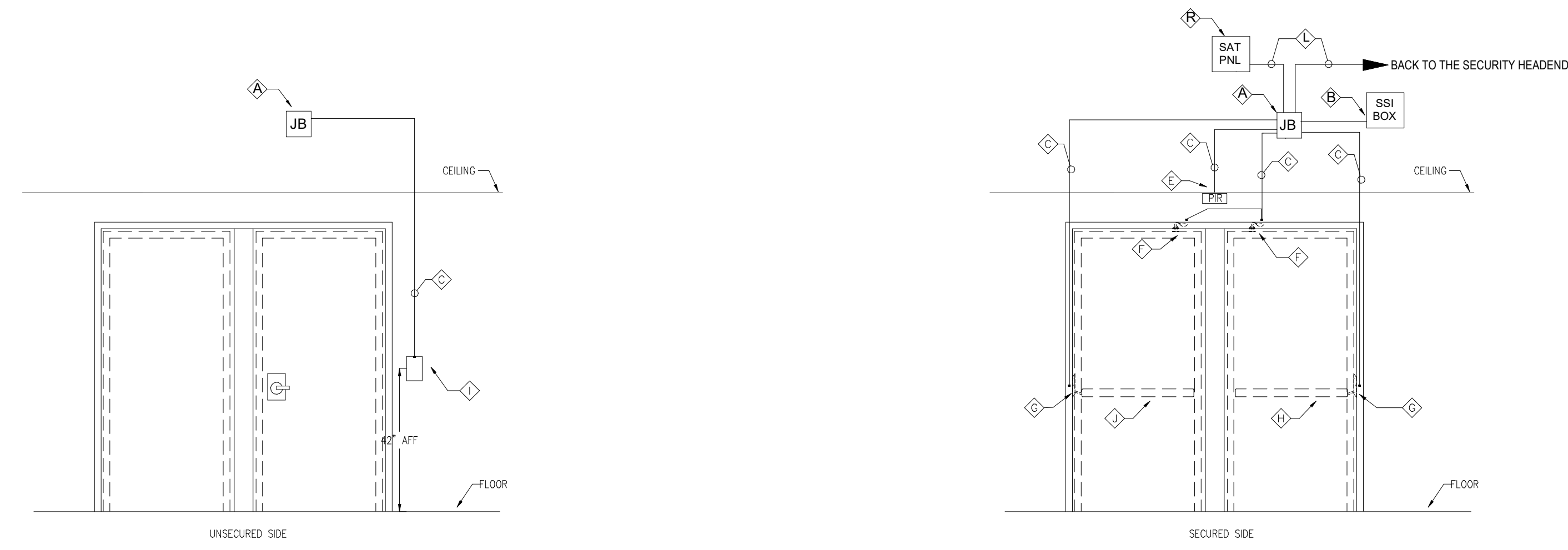

3 EXTERIOR DOUBLE DOOR WITH (1) CARD READER, ELECTRIFIED EXIT, AND MONITORED EXIT DETAIL
Scale: N.T.S.

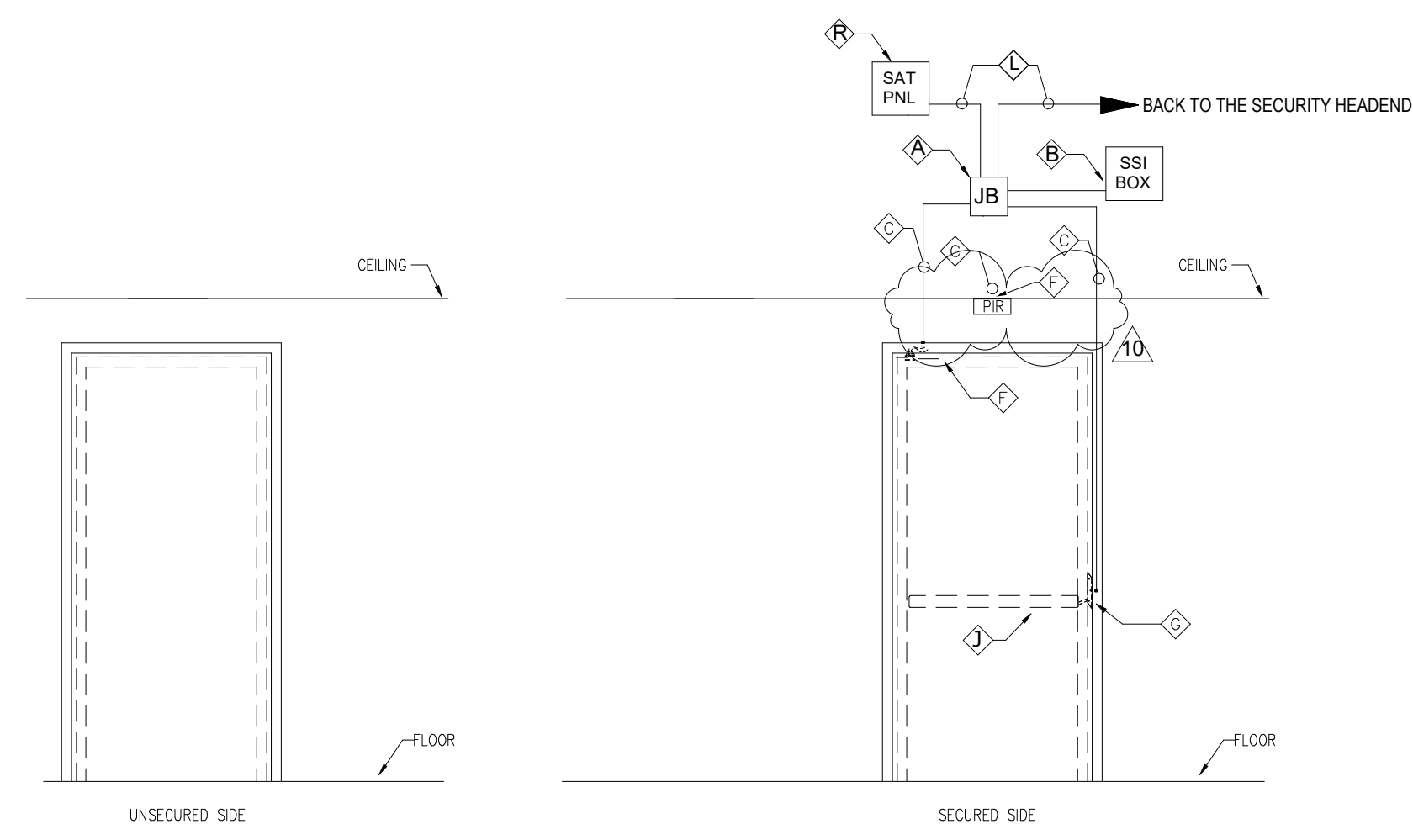

4 EXTERIOR SINGLE MP DOOR, MECHANICAL EXIT DETAIL
Scale: N.T.S.

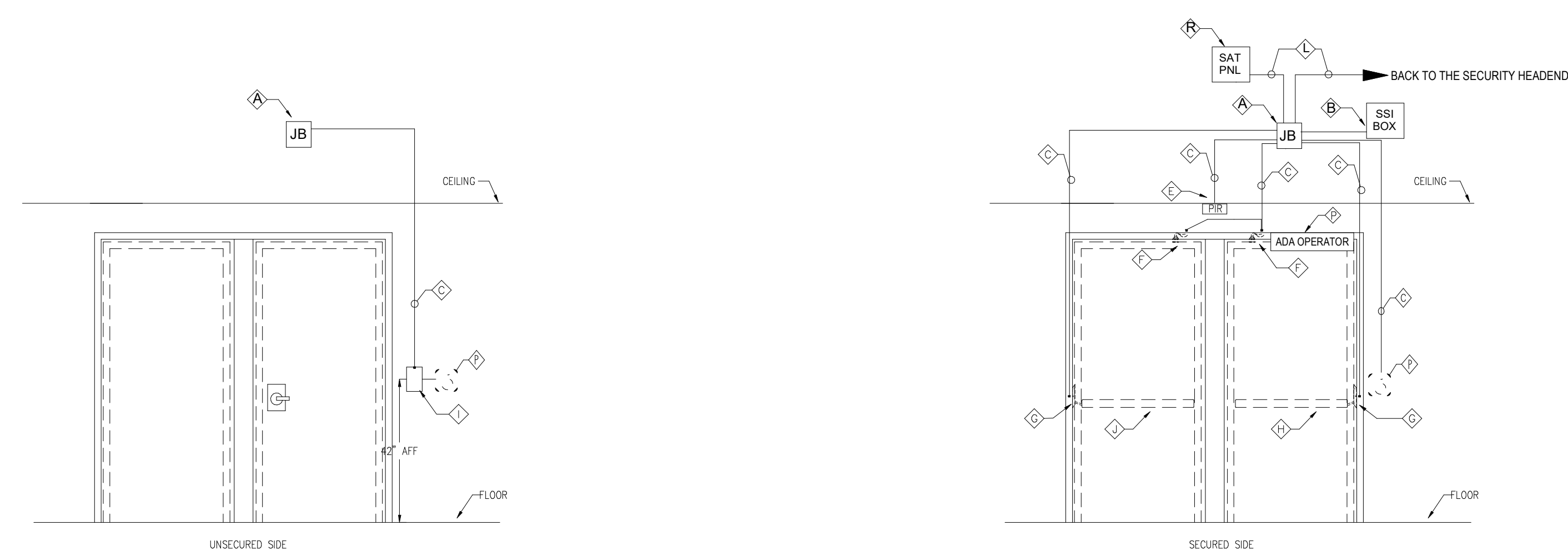

5 EXTERIOR DOUBLE DOOR WITH (1) CARD READER, ELECTRIFIED EXIT, ADA PUSH BUTTONS, AND MONITORED EXIT DETAIL
Scale: N.T.S.

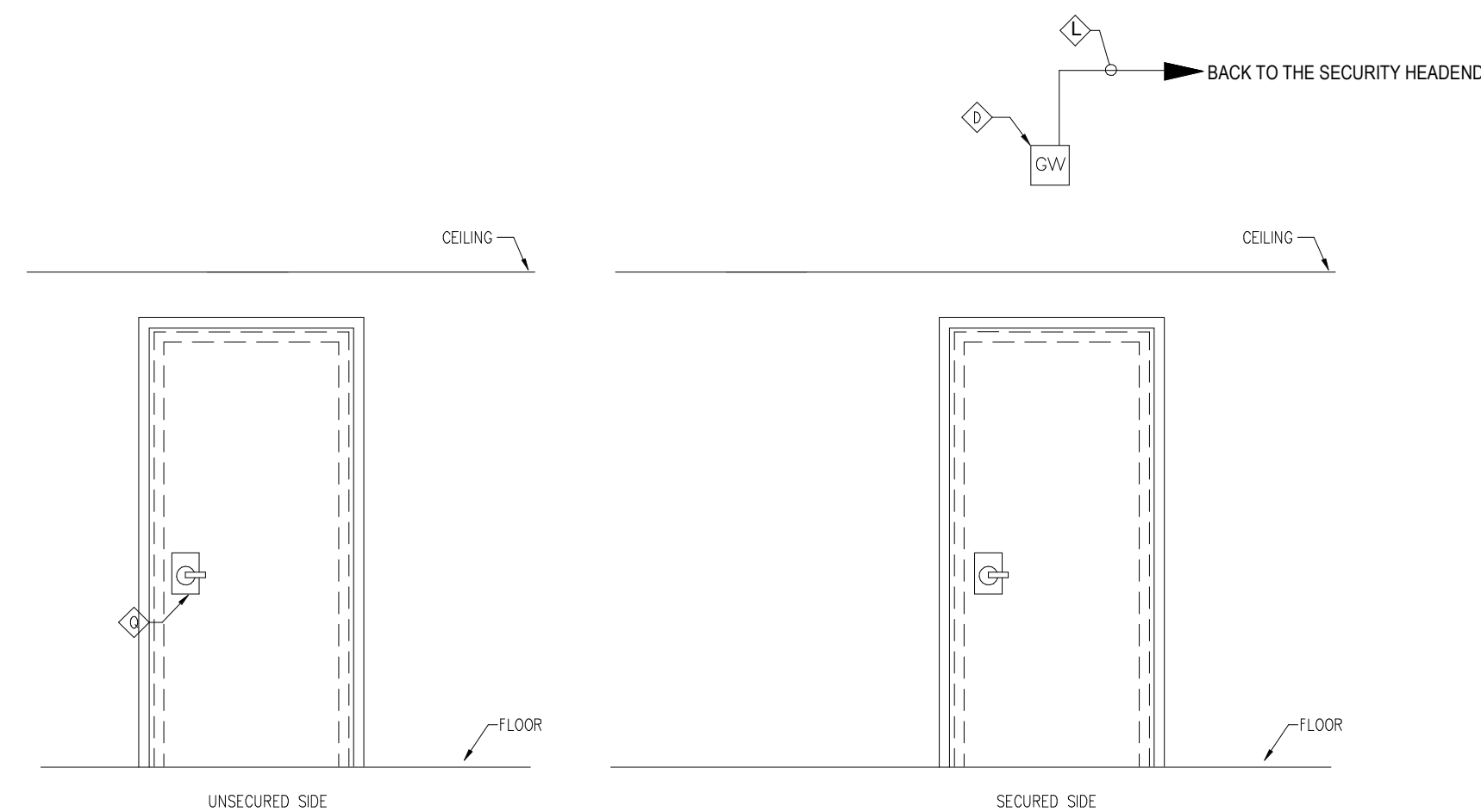

6 INTERIOR SINGLE DOOR WITH (1) WIRELESS CARD READER DETAIL
Scale: N.T.S.

SECURITY LEGEND	
MARK	DESCRIPTION
⬠	12" X 12" X 8" JUNCTION BOX PROVIDED BY ELECTRICAL CONTRACTOR.
⬢	REFER TO SSI DETAILS FOR ADDITIONAL INFORMATION.
⬢	1/2" CONDUIT INSTALLED BY ELECTRICAL CONTRACTOR
⬢	WIRELESS GATEWAY INSTALLED AND PROVIDED BY NC STATE SECURITY CONTRACTOR.
⬢	PIR REQUEST TO EXIT/SOUNDER PROVIDED AND INSTALLED BY NC STATE SECURITY CONTRACTOR. ELECTRICAL CONTRACTOR SHALL PROVIDE CONDUIT PREP AND FRAME PREP BY DOOR HARDWARE CONTRACTOR.
⬢	DOOR POSITION SWITCH PROVIDED AND INSTALLED BY NC STATE SECURITY CONTRACTOR. ELECTRICAL CONTRACTOR SHALL PROVIDE CONDUIT PREP AND FRAME PREP BY DOOR HARDWARE CONTRACTOR.
⬢	ELECTRIFIED TRANSFER HINGE INSTALLED BY DOOR HARDWARE CONTRACTOR. ELECTRICAL CONTRACTOR SHALL PROVIDE INFRASTRUCTURE.
⬢	ELECTRIFIED EXIT DEVICE WITH INTERNAL REQUEST-TO-EXIT SWITCH AND LATCH BOLT MONITOR INSTALLED BY DOOR HARDWARE CONTRACTOR. ELECTRICAL CONTRACTOR SHALL PROVIDE INFRASTRUCTURE.
⬢	PROVIDE SINGLE GANG BOX FOR CARD READER OR KEYPAD CARD READER PROVIDED BY NC STATE SECURITY CONTRACTOR. MOUNT SINGLE GANG BOX 6" - 10" FROM DOOR FRAME. READERS SHALL NOT BE MOUNTED BACK TO BACK.
⬢	MECHANICAL EXIT DEVICE WITH INTERNAL REQUEST-TO-EXIT SWITCH AND LATCH BOLT MONITOR INSTALLED BY DOOR HARDWARE CONTRACTOR. ELECTRICAL CONTRACTOR SHALL PROVIDE INFRASTRUCTURE.
⬢	ELECTRICAL CONTRACTOR SHALL PROVIDE 5/8"x4" JUNCTION BOX.
⬢	1" CONDUIT INSTALLED BY ELECTRICAL CONTRACTOR.
⬢	ELECTRIFIED MORTISE LOCK WITH REQUEST-TO-EXIT AND LATCH BOLT MONITOR INSTALLED BY DOOR HARDWARE CONTRACTOR.
⬢	SECONDARY ACCESS CONTROL PANEL PROVIDED BY NS STATE SECURITY CONTRACTOR.
⬢	POWER SUPPLY FOR DOOR LOCK BY DOOR HARDWARE CONTRACTOR. ELECTRICAL CONTRACTOR SHALL PROVIDE DEDICATED 120VAC CIRCUIT AND CONNECTIVITY.
⬢	ADA OPERATOR AND PUSH PLATES INSTALLED BY DOOR HARDWARE CONTRACTOR. ELECTRICAL CONTRACTOR SHALL PROVIDE INFRASTRUCTURE.
⬢	WIRELESS INTEGRATED CARD READER, LOCK, REX, AND CONTACT INSTALLED BY DOOR HARDWARE CONTRACTOR.
⬢	ELECTRICAL CONTRACTOR SHALL MOUNT READER MODULE ENCLOSURE (15" W X 13" H X 4" D) PROVIDED BY NC STATE SECURITY CONTRACTOR. CONTRACTOR SHALL LEAVE 16" IN FRONT OF PANEL CLEARANCE FOR 90 DEGREE DOOR SWING AND WORKSPACE.
⬢	MULLION MOUNTED CARD READER PROVIDED BY NC STATE SECURITY CONTRACTOR. MOUNT 42" AFF. PROVIDE RACEWAY IN DOOR FRAME FOR CARD READER.